



NOISE EMISSIONS DURING BELT OPERATION

NOISE EMISSIONS DURING BELT OPERATION

Abstract	2
1 How do you define noise?	3
2 General influencing factors on the noise emissions from conveyors	4
3 Noise emissions from conveyor belts	5
4 Noise measurement at Forbo	8
5 Measurement results	12
6 Conclusion	16

Abstract

Internationally, legislators specify compliance with certain thresholds in workspaces and public areas. OEMs are also very interested in components that cause as little noise as possible (e.g. treadmills, conveyors etc.). Which explains why noise emission is growing in importance and triggering increasing demand worldwide for conveyor belts that are as quiet as possible.

Unfortunately, the DIN and OSHA measurement methods are unsuitable for assessing which belt type is best for a particular system or machine in terms of noise emissions (in other words, which is the quietest). The reason is that they always evaluate a system as a whole and not each of the components – such as the belt. Which is why Forbo Movement Systems developed its own testing standard to measure and evaluate the noise emissions of a belt (and other parts of the machinery) in isolation.

The following outlines cover fabric-based, friction-driven conveyor belts.

Whitepaper
Noise emissions during belt operation · 08/24

Reprinting, reproduction – also just partially – only with our permission. Subject to change.

Forbo Siegling GmbH
Lilienthalstrasse 6/8, D-30179 Hannover
Phone +49 511 6704 0
www.forbo-siegling.com, siegling@forbo.com

1 How do you define noise?

Noise or sound are vibrations that the human ear can perceive (20 – 16000 Hz). Sound can be transmitted through air and gases (air-borne noise), solid media (structure-borne noise) and in fluids (fluid-borne noise).

Noise from a conveyor belt

In conveyor belts, noise is almost always air-borne, in other words, pressure waves caused by fluctuations in air pressure.

Sound pressure

Sound pressure is the pressure deviation from static (atmospheric) pressure, caused by a pressure wave. This sound pressure can be measured with microphones or pressure transducers, but the measurement results run into several figures.

Sound pressure level

Which is why, to obtain small numbers, it's not the absolute pressure values that are stated but the relative sound pressure level in decibels (dB). This is calculated from the sound pressure using an internationally defined reference value and plotted logarithmically against the frequency. However, our ears don't hear objectively so don't perceive equal sound pressure levels at different frequencies as equally loud or equally unpleasant.

Weighted sound pressure level

Which is why there are weighting curves to indicate to what degree objectively measured sound pressure needs to be corrected in dB to approximate the natural volume our ears can hear. In practice, weighting curves that approximate the frequency sensitivity of the ears to common ambient sounds (curve A) are usual. The weighted sound pressure level is stated as dB(A).

NOISE EMISSIONS DURING BELT OPERATION

2 General influencing factors on the noise emissions from conveyors

A conveyor's sound pressure level is measured based on a DIN standard at a height of 1.6 m and distance of 1 m to the side of a machine. This means it's not a variable specific to a machine or part of a machine but depends on a range of different factors, such as:

- The type of conveyor and design (horizontal, inclined, swan-neck conveyors)
- The drum type
- The type of drive (drum or flange motor)
- Bearing type and load (drum deflection; bearing noise)
- Belt support:
 - Slider bed (material, thickness and roughness)
 - Idler rollers (material, coating, position, distance, angle to the direction of travel)
 - Belt support with fixed bars
- The number of conveyors in the room (whole system)
- Size of the space (reverberation)
- Condition of the space (reflectivity of the walls)
- Type and design of the conveyor belt

An international comparison of standards and legal threshold

The following table provides an overview of the global requirements in working environments regarding the maximum sound pressure level permitted.

	Germany and Europe	US	Asia (China)*
Origin of specification	Diverse statutory and labor law regulations	OSHA Key players (UPS)	Key players (DHL)
Threshold permitted	< 70 dB(A) activity category 2 from ArbStättV ASR A3.7 Noise < 70 dB(A) EC Machinery Directive 2006/42/EC < 80 dB(A) compliant with DIN EN ISO 9612	< 85 dB(A) (OSHA) < 77 dB(A) (key players)	< 72 dB(A)
Distance from the source of noise	1.6 m height and 1 m distance (EC Machinery Directive 2006/42/EC)	– Measurement on the body (shoulder) of a worker at 1.6 m height (OSHA) – 1.0 m from the source of the noise (key players)	1.5 m from the source of noise

* Requirements are currently only being made in China.

3 Noise emissions from conveyor belts

Therefore, the conveyor belt is only one of several factors that has an impact on the noise a conveyor makes. The noise conveyor belts make when running usually occurs in the following form:

- The sliding noise a conveyor belt makes when its underside glides over the slider bed or the top face moves over a fixed drum
- A tearing noise on the top face of the belt over the drum on the return side (i.e. the snub roller or support drum)
- The impact noise of the fabric threads perpendicular to the direction of travel against drums
- Special case: Impact noise of mechanical fasteners

Factors influencing noise emissions

The following factors influence sliding or abrasion noise, so are variables when it comes to cutting noise:

- The underside fabric (weave type, fabric design, etc.)
- Thickness of the top face coating
- Hardness of the top face coating
- Top face pattern
- Elongation at fitting
- Arc of contact
- Velocity
- Angle of the fabric threads perpendicular to the direction of travel

NOISE EMISSIONS DURING BELT OPERATION

Impact of the conveyor belt/fabric weaves' underside

Fabrics with a range of weaves, such as plain weaves or twill, are used to make conveyor belts.

Plain weave:

In plain weave, each warp thread passes over and under each weft thread in an alternating manner. Therefore, warp and weft threads are most closely interlaced in plain weaves.

The twill weave family:

Twill weaves are produced by a crisscrossing of threads that result in a pattern like a staircase. This creates parallel, diagonal lines in the fabric (twill line).

The twill line can rise to the left (left-hand twill), to the right (right-hand twill), or alternately to the left and right.

Forbo Siegling's belts are almost exclusively made of twill weaves which are an even mix of left-hand and right-hand twill.

Broken twill weave:

One such twill weave which is an even mix of left-hand and right-hand twill is broken twill.

3x1 broken twill weave also stands apart because the warp threads are primarily on one side of the fabric (warp float). Therefore, fabrics woven like this have two very different sides. The side with warp floats feels smooth in a lengthways direction, whereas the other side feels rough in a lengthways direction.

If a fabric of this type is used, with its smooth side facing downwards, as a conveyor belt's bottom fabric layer, it can cut noise.

However, fabrics with 3x1 broken twill weave are at a disadvantage when it comes to bending rigidity.

The lack of a hinge effect (compared to plain weave) results in more bending stiffness. Therefore, the twill weave isn't suitable for knife edge belts.

Pointed twill weave:

Pointed twill weave is also a weave where the direction of the twill line alternates at regular intervals on the fabric. If a fabric with pointed twill weave is used, with its smooth side facing downwards, as the bottom fabric layer in a conveyor belt, it can also cut noise.

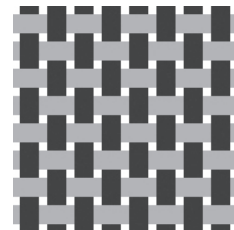

Diagram: Plain weave

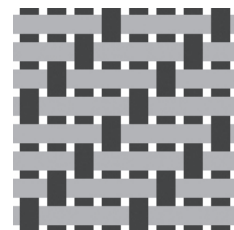

Diagram: Twill weave, right-hand twill

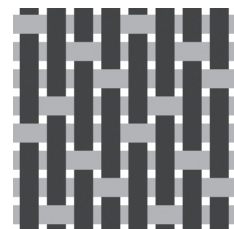

Diagram: 3x1 broken twill weave; alternately left-hand and right-hand twill

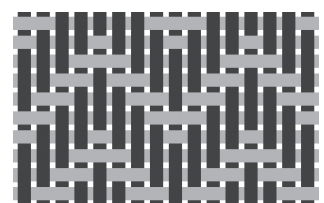

Diagram: pointed twill weave; alternately left-hand and right-hand twill

NOISE EMISSIONS DURING BELT OPERATION

Silent fabric:

Forbo has developed multiple complex fabric designs from basic fabric weaves for a wide variety of applications. One of the development goals was to cut the noise belts make when running. Trials on the test rig showed that the weave type and fluffiness of the fabric played a major role in the noise emitted. The findings from numerous tests led to the development of the Silent fabric.

The Silent fabric combines two aspects of a fabric, both of which lead to a reduction in running noise. The Silent fabric isn't just a pointed twill weave, its warp threads are also made of a staple fiber yarn whose fluffiness equally helps cut noise.



Microscopic image of a staple fiber yarn

Impact of the conveyor belt's top face

A conveyor belt emits noise from the top face coating when it moves onto and leaves the idler rollers and end drums or support rollers on the return side. The conveyor belt's key variables that can have an impact are as follows:

- Top face coating pattern
- The coating's hardness
- The coating's thickness

The type of pattern is the factor that has the biggest impact. In other words, a continuous pattern is ideal so that any tearing off the drum is avoided or reduced.

Therefore, the LG pattern (longitudinal groove) has the lowest noise emissions. The continuous ridges prevent tearing noise.

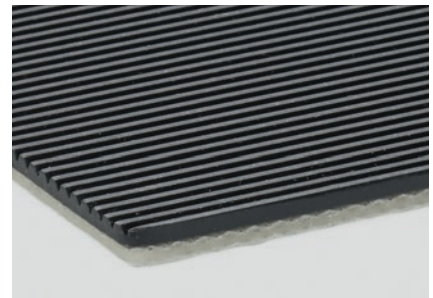

Conveyor belt with an LG pattern:
Transilon E 8/2 U0/V15 LG black

NOISE EMISSIONS DURING BELT OPERATION

4 Noise measurement at Forbo

To decrease noise emissions from conveyor belts, Forbo Movement Systems has been carrying out noise measurements based on internal standards for many years. Forbo has a dedicated acoustic space to carry out comparative noise measurements. This space has a conveyor on which all belt types can be tested on different roller or slider bed designs. The sounds emitted can be assessed based on the sound pressure level and in even greater detail via a frequency analysis.

What makes this noise test rig so special is that the motor- and ambient-noise are eliminated thanks to a casing. What's more, at the design phase, drum and bearing noises were minimized. Therefore, the objective of this measurement method differs significantly from the DIN and OSHA's. Their regulations specify that noise emissions have to be measured on a whole conveyor/machine. The Forbo test rig on the other hand is designed to extract the operational noise the belt or any other components emit in the best possible way. This makes both belts and other components comparable with each other in terms of the role they play in the noise a conveyor generates overall.

According to the current Forbo standard, overall noise* is identified under the following conditions (see figure on the following page):

	Current Forbo standard (SN1008.20.2)
Belt tracking on the carrying side	Underside of the belt (usually the fabric side) with contact to the support
Belt tracking on the return side	Top face of the belt (usually the coated side) when operating over the support roller (roller adjusted to the maximum noise generated)
Belt velocity	0.8 m/s and 3 m/s (in high-speed applications)
Positioning noise meter	1 m at the side of the source of the noise



Acoustic room with a noise test rig.

* In this case, it's not the total noise of a conveyor that's meant, but the noise generated by the conveyor belt when it runs over the whole test rig.

NOISE EMISSIONS DURING BELT OPERATION

The test rig can be operated without any support on the carrying side or without a return roller on the return side. As a result, the noise emissions of components (e.g. different return rollers, supports etc.) can be compared (see also figures on the following page).

The purpose of the noise measurements on the test rig is to reveal tendencies and help select suitable conveyor belts or other components.

Drawing of the test rig based on the Forbo standard

(measurement of the overall noise)

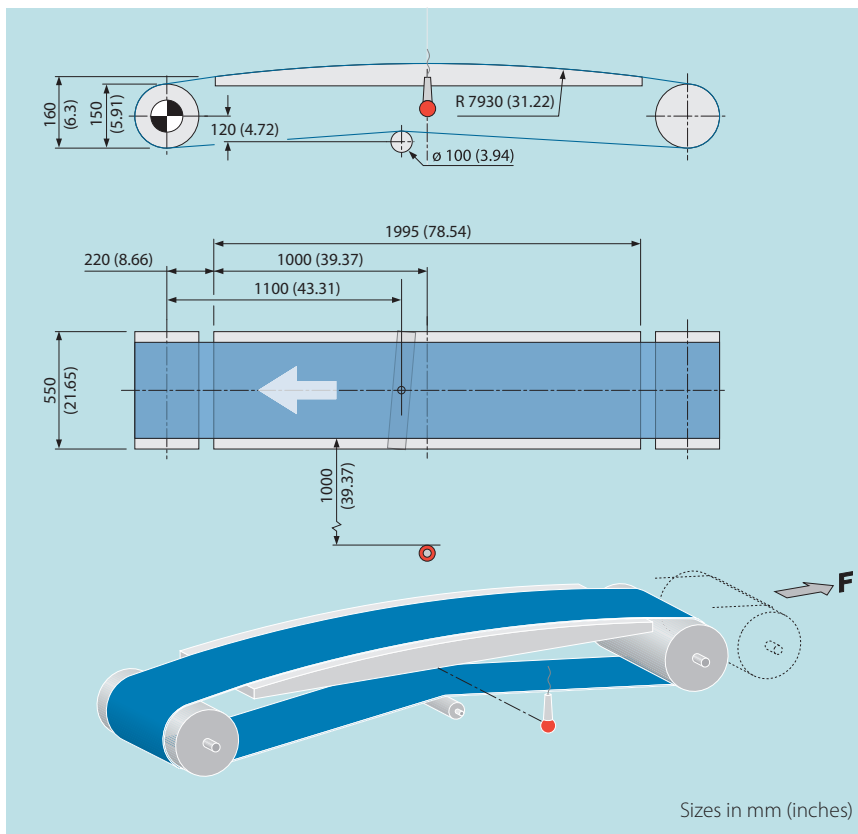

Belt tracking on the carrying side over the slider bed at 0.8 m/s and 3 m/s (in high-speed applications)

Belt tracking on the return side over a roller (roller adjusted to generate maximum noise) at 0.8 m/s and 3 m/s (in high-speed applications)

The preload force F is constant and generated at a tensioning weight of 100 kg.

NOISE EMISSIONS DURING BELT OPERATION

Drawing of the test rig based on the Forbo standard
(for measurements on the carrying side)

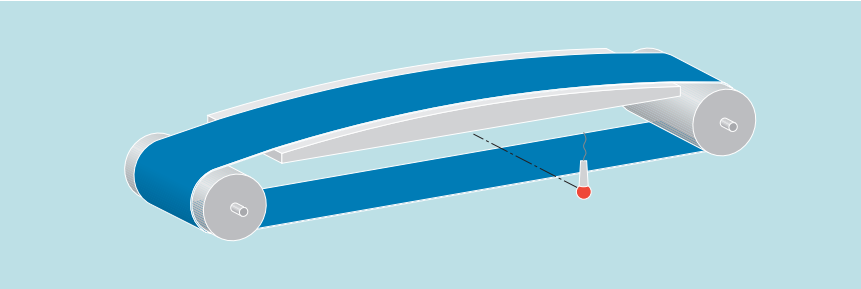

Drawing of the test rig based on the Forbo standard
(for measurements on return rollers)

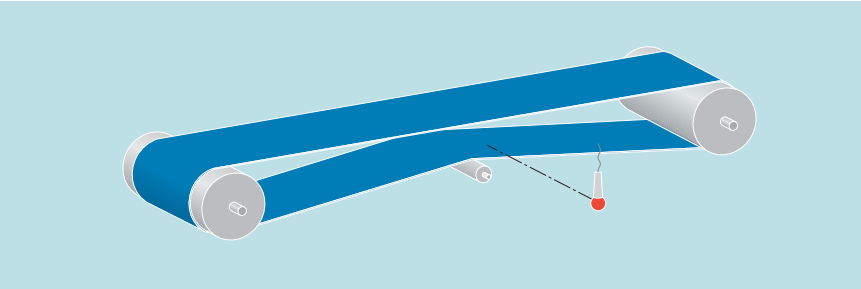

NOISE EMISSIONS DURING BELT OPERATION

Tests on various belt supports on the return side

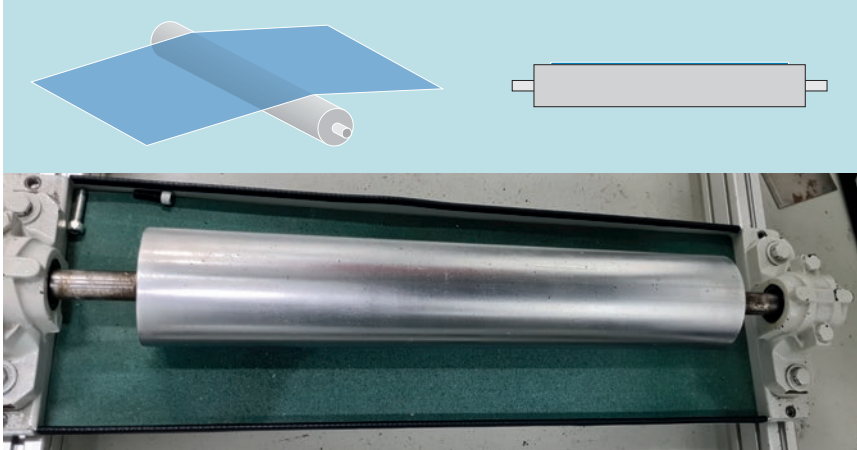

Standard drum

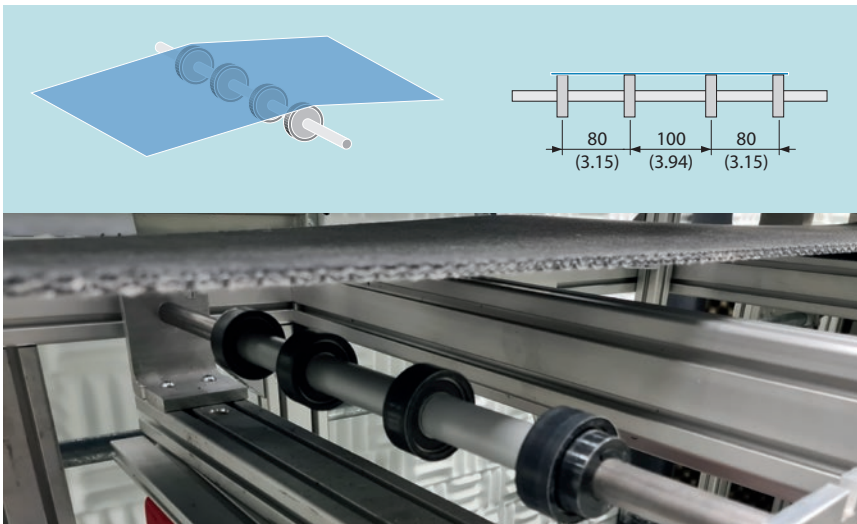

Belt support with less contact area
(ball bearings inserted and PU coated sheathing)

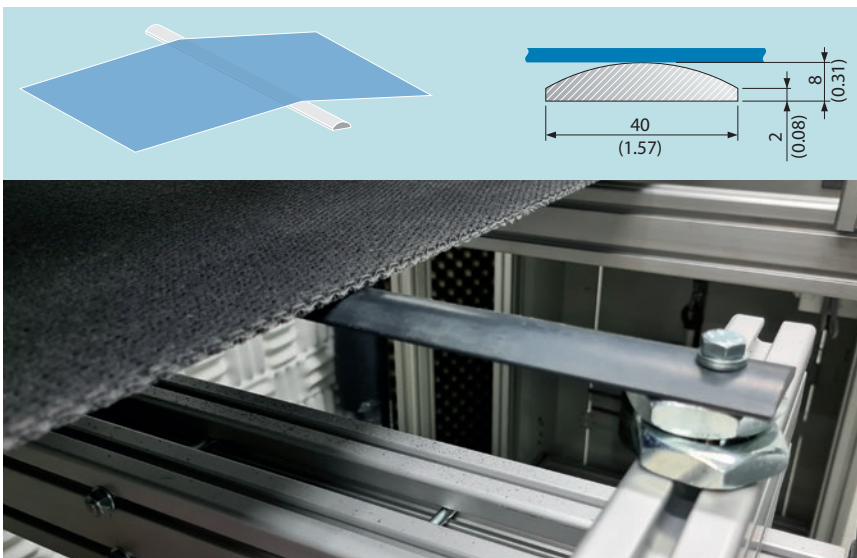

Metal rod with a semi-circular profile

NOISE EMISSIONS DURING BELT OPERATION

5 Measurement results

Please note that all the figures in the following diagrams are based on results from test rig measurements. The sound pressure levels shown were established based on our internal standard. On the carrying side, the belt passes over a slider bed and on the return side, with its top face over a roller or other supports. The absolute noise development on conveyor in the real world can differ from these measurements.

To adapt testing conditions to those in the real world, tests are conducted at different belt speeds which are based on the belt types' operating conditions.

Comparison of individual measurements with the total noise level

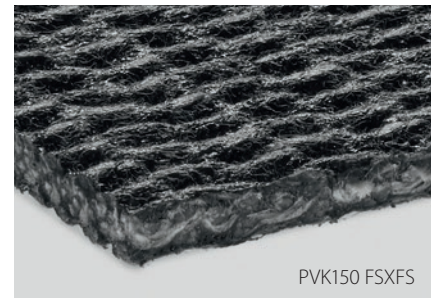
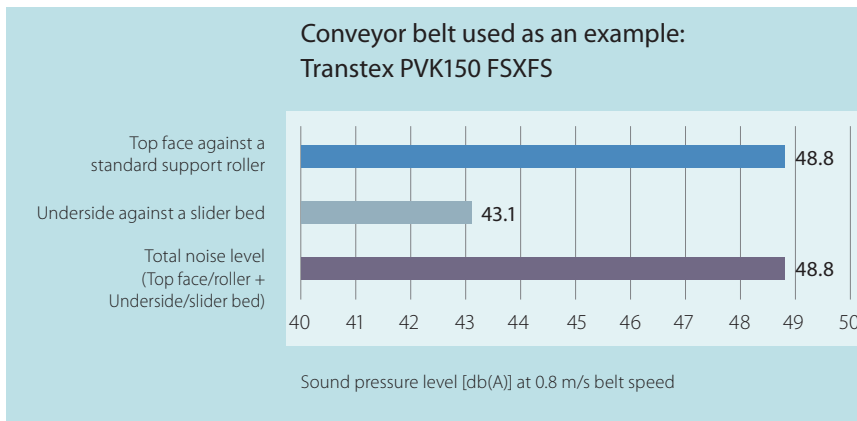

PVK150 FSXFS

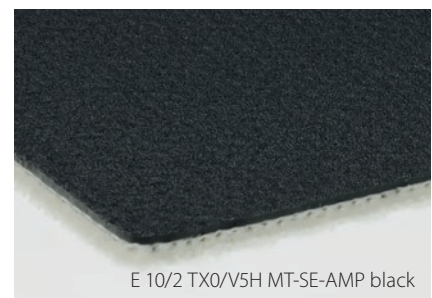
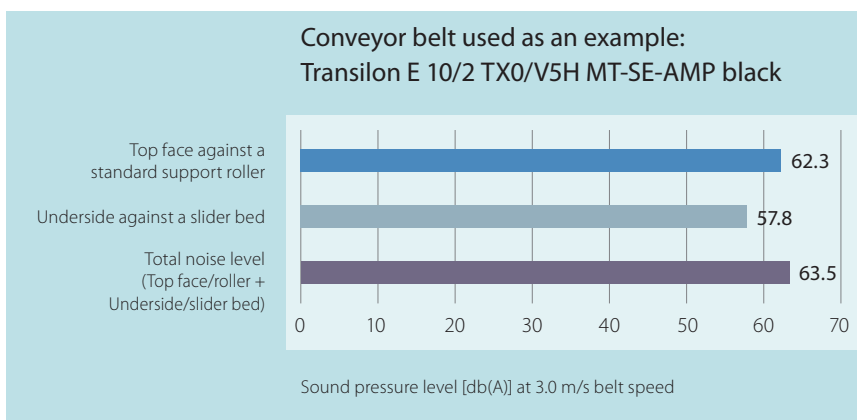

E 10/2 TX0/V5H MT-SE-AMP black

In this measurement, you can clearly see that the sound pressure levels of various objects emitting the sound don't accumulate linearly because the sound pressure level is a logarithmically scaled quantity.

The total noise level (sound pressure level), which occurs when a belt's underside tracks over a slider bed and its top face tracks over support rollers at the same time, is primarily determined by the louder of the two noises (sound pressure level) and is at a similarly, slightly higher level in dB(A). In these two examples, the total noise level is determined when the belt tracks over the support roller.

NOISE EMISSIONS DURING BELT OPERATION

Comparison of the single sound levels where there are different belts supports on the return side

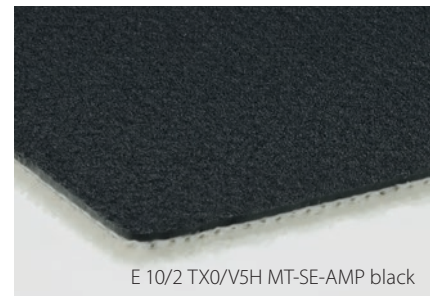
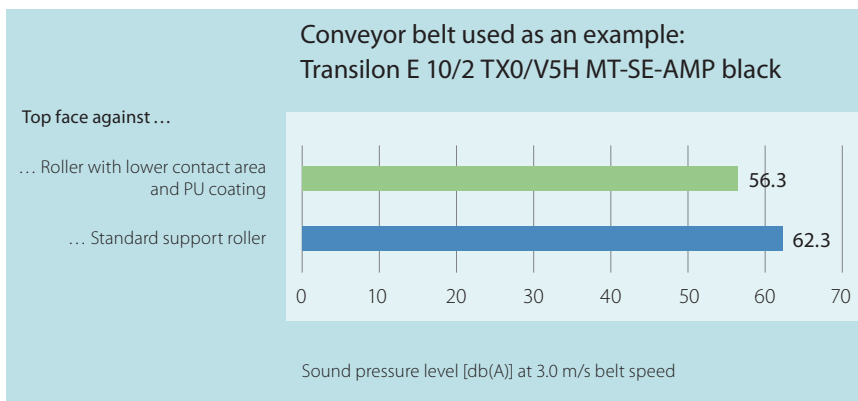
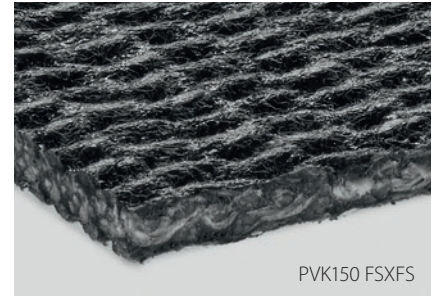
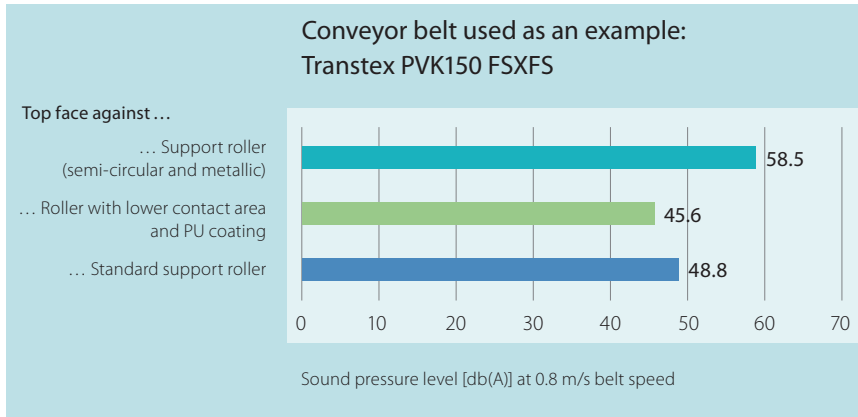

It's not just the characteristics of the belt or the test that have an impact on the sound pressure level, but the type of support rollers on the return side that the top face tracks over.

In general, contact of the top face with the support roller with a reduced contact area and PU coating results in a lower sound pressure level than contact with the standard support roller.

NOISE EMISSIONS DURING BELT OPERATION

Comparison of the total noise levels where the return side has different belt supports

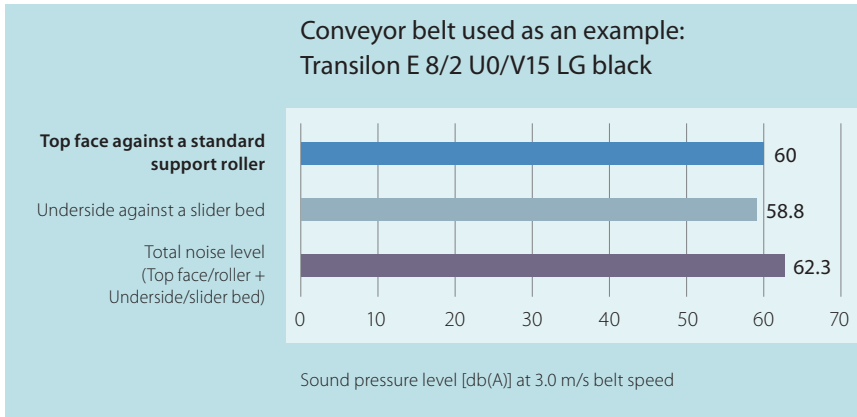

When a standard support roller is used:

Any contact between the top face and standard support roller produces a higher figure than for contact between the underside and slider bed.

In this case, the sound pressure level of the total noise level is only slightly higher than the sound pressure level of the top face/standard support roller.

In this case, improving the underside would only have minimal influence on the total noise level (sound pressure level).

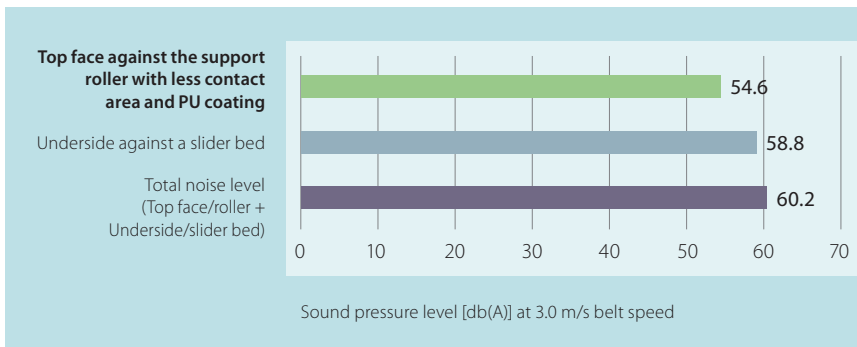

Using a support roller with less contact area and PU coating:

Any contact between the top face and support roller with less contact area and a PU coating produces a lower figure than when contact between the underside and slider bed occurs.

In this case, the magnitude of the total noise level (sound pressure level) is determined from the sound pressure level that occurs during contact between the underside and slider bed.

In this case, improving the underside would have an impact on the total noise level (sound pressure level).

NOISE EMISSIONS DURING BELT OPERATION

Comparison of individual noise levels on the carrying side (Underside against the slider bed) with various belt types

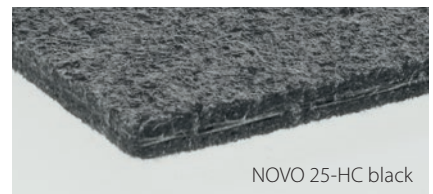
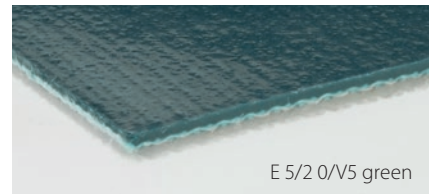
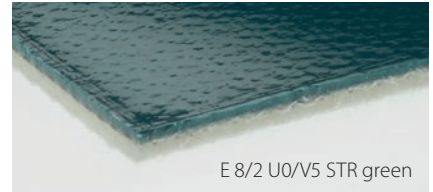
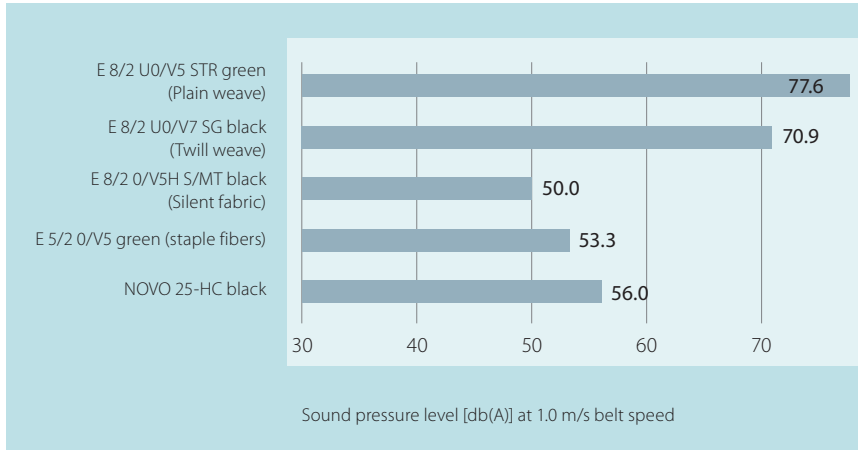

Depending on the weave and the design of the belt as a whole, the individual measurements exhibit vast differences in the sound pressure level generated.

The sound pressure levels shown were established based on an earlier internal measurement standard (microphone at 20 cm distance above the top face). The figures should only be used to assess ranking.

NOISE EMISSIONS DURING BELT OPERATION

6 Conclusion

The objective and results of noise measurements on conveyor belts and other components on the test rig are very different from measurements based on DIN and OSHA standards, each of which analyze whole conveyors.

Measurements on the test rig make both belts and other components comparable with each other in terms of the role they play in the noise a conveyor emits overall. These findings are becoming increasingly important in view of rising conveying velocities and provide valuable insights that are incorporated in current development projects at Forbo.

There's a whole range of belt types that can already be used in noise-sensitive areas. These generate exceptionally low noise when they run over a slider bed or on the return side.

As these measurement results suggest, their low noise emissions only mitigate the total noise level of the conveyor if other components (motors, drive chains, bearings, etc.) aren't even noisier.

Forbo has mobile noise meters to carry out on-site measurements on conveyors. If required, reach out to the application engineering department at Forbo Siegling Hanover.

NOISE EMISSIONS
DURING BELT OPERATION

Siegling – total belting solutions



MOVEMENT SYSTEMS