

siegling extremultus flat belts

PRODUCT RANGE



Not always visible, yet present everywhere, Forbo Movement Systems makes sure that your logistics and production workflow run smoothly and optimally.

Our solutions are characterized by a high level of efficiency, precision and reliability. We are in global demand as an expert partner in the development of industry-specific and future-oriented solutions for drives, conveyor systems and manufacturing.

You can find brochures with more information on using Siegling Extremultus belts at:
www.forbo.com/movement
> Downloads > Product Brochures
> Siegling Extremultus



SIEGLING EXTREMULTUS FOR POWER TRANSMISSION, CONTROL AND CONVEYING TASKS

Siegling Extremultus high efficiency flat belts are easy to handle and track superbly even at high speeds. Available in various designs they enhance power transmission and conveying in many industries.

Siegling Extremultus is used successfully in a broad range of applications in industries such as:

- **Drive technology**
- **Paper and cardboard box manufacturing and processing**
- **Yarn manufacturing**
- **Distribution processes**
- **Food processing**

In these areas, Siegling Extremultus belts can often play a key role other than just transmitting power.

The structure of the tension member and the coatings on the underside and top face govern the characteristics of the flat belt. The Siegling Extremultus range includes diverse lines with various tension members and types of coating based on these.

This variety means a vast choice of different types to enable sophisticated, cost-saving designs and efficient operation of machinery.

Contents

4	Special strengths of flat belts
6	Design and materials
10	Application groups
14	Manufacturing tolerances
15	Delivery dimensions

The current product range can be found under the following link:

https://forbo.blob.core.windows.net/forbodocuments/7261/216_0.pdf



SPECIAL STRENGTHS OF FLAT BELTS

Flat belt drives can be used at high speeds, can transmit high power and are extremely efficient. They boast other interesting advantages:

Versatile and simple drive design

Due to their great flexibility and the option of using both sides of the belt for drive tasks, flat belts can be used in a wide variety of drive configurations (see series of figures on next page).

As flat belts are custom made, there is no need to adhere to standardized lengths and widths when designing the drive. Due to their flat design, flat belts enable relatively low drum diameters. The even surface also makes the drive and drum pulleys easy to manufacture and thus cost-effective.

Long lifetimes

Flat belts boast long lifetimes due to their high abrasion resistance. The constant friction coefficient guarantees constant RPMs across the entire service life. The materials used for tension members (polyester, aramide and polyamide) maintain their tension extremely well, necessitating re-tensioning in exceptional cases only. Flat belts with plastic tension members and elastomer coatings are maintenance-free.

Chrome leather coatings, used mainly for heavy duty drives, must be treated from time to time with a special spray paste in order to maintain smooth tracking and slip behavior.

High efficiency

Flat belts are significantly more efficient than V-belts and V-ribbed belts. This is mainly due to friction losses. In addition to losses resulting from slip and hysteresis, which are minimal with flat belts and at times considerably higher with V-belts and V-ribbed belts, the edge friction present with V-belts and V-ribbed belts can also lead to friction losses. The more pronounced the wedge, the higher the contact surface between the edges of the wedge and the pulley. As the contact surface increases, so too does the edge friction and the friction losses.

When it comes to flat belts, the loss of efficiency as a result of slip is so minimal that the efficiency (> 98%) is in the range of form-fit drives such as timing belt drives and gear drives and sometimes even greater.

Low operating noises

Flat belts produce high-frequency, low-amplitude noise. The coating on the underside of the belt can minimize noise, e.g. select a chrome leather layer or texture the elastomer layer. That is why flat belts generate considerably less operating noise than V-belts or V-ribbed belts.

Wide range of application

Practically speaking, considering flat belts as pure drive elements often falls short. In addition to the classical drive function, they also provide great support when it comes to industrial (production) processes; e.g. processing boxes.

Flat belts have also been performing conveyor tasks for years. This has been primarily in the field of electronics and the food industry, including the manufacture of solar cells and the production of baked goods. These processes are far too complex for other types of belts.

- Flat belts are the only ones that can execute the necessary, sometimes highly complex, belt processes.
- Only flat belts have such a wide range of different characteristics at their disposal, including the fact that they can be food-safe and ESD compatible, etc.
- Only flat belts can be individually sized and fabricated, including the option of belt edge processing and the application of profiles etc.

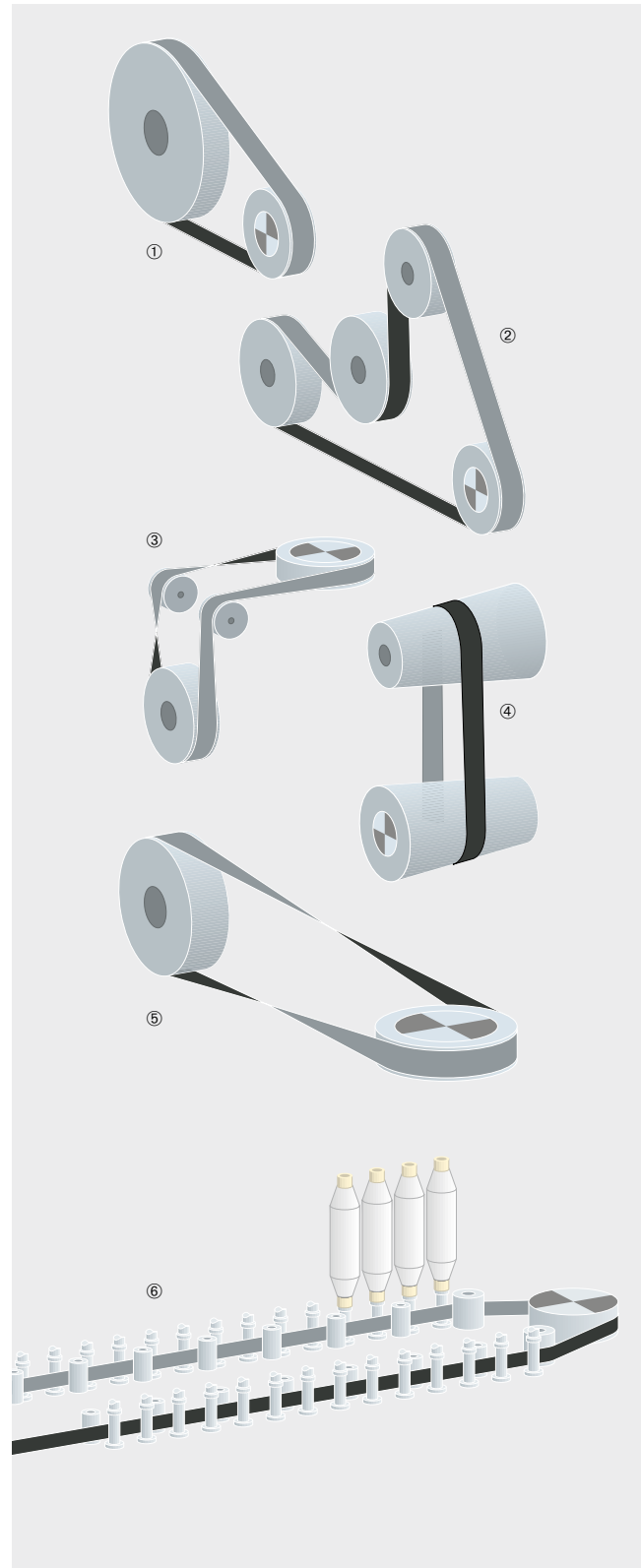

DESIGN AND MATERIALS

Structural diagram of a flat belt

Top face

Tension member

Underside

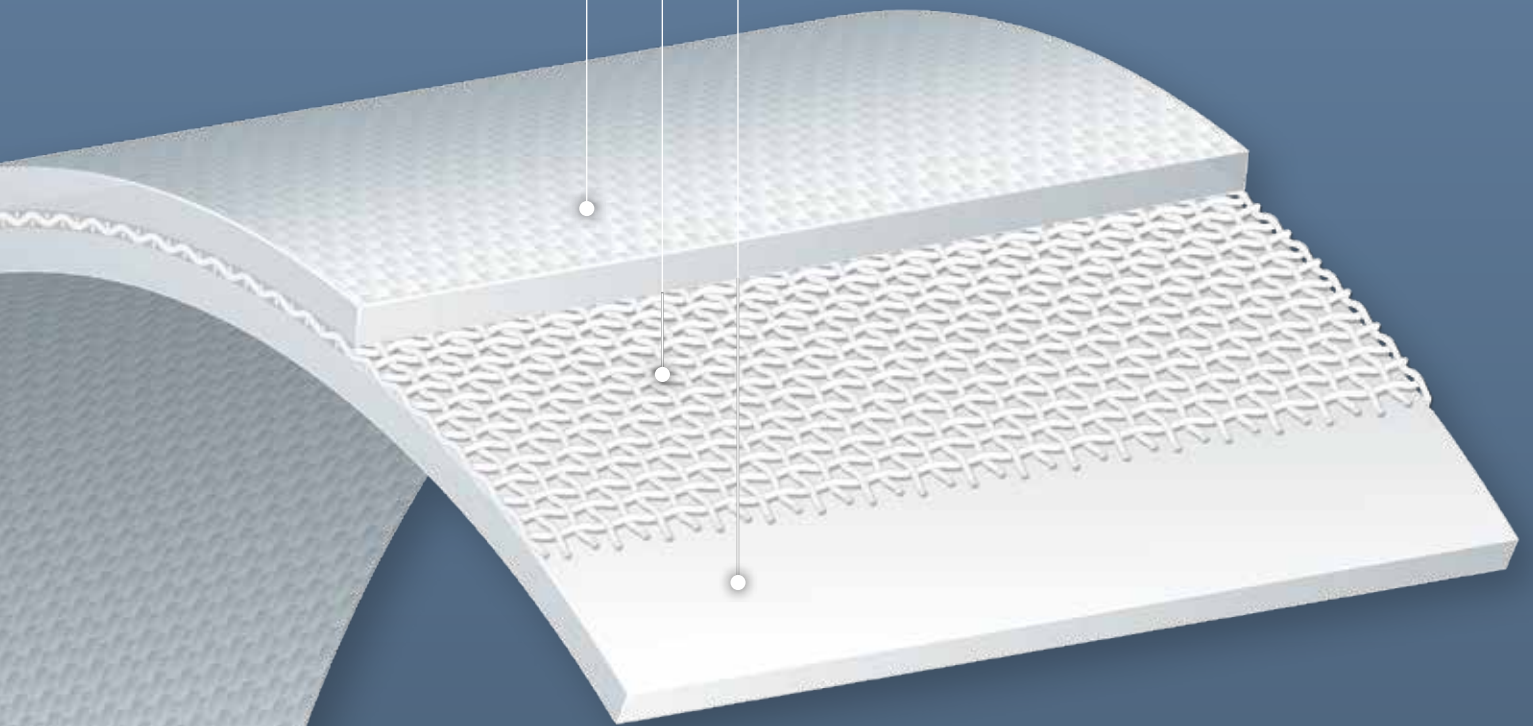

Tension member design

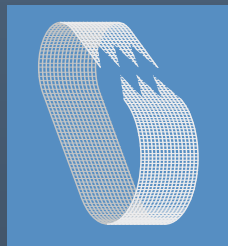

Fabric in warp and weft



Sheet (highly oriented)
or Foil (elastic)

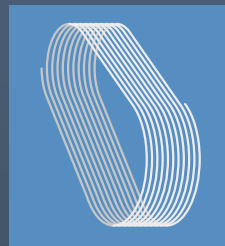

Truly endless cord

The diagram (page 6) depicts the construction of a flat belt made up of a tension member as well as coatings on the top face and the underside. Depending on the choice of material and the sub-type etc., flat belts have very different properties, making them suitable for a wide variety of applications.

Tension member

The technical properties of a flat belt are primarily determined by its tension member. For this reason, Siegling Extremultus flat belts with the same tension member materials are grouped in product lines.

Tension member materials

- A = Aramide line
- E = Polyester line
- P = Polyamide line
- U = Polyurethane line

Coating

The coatings are in direct contact with the drive pulleys (generally the underside of the belt) and, where necessary, with the product to be conveyed (generally the top face of the belt). Skillful selection of the material and surface pattern make it possible to determine contact-specific properties such as grip, chemical resistance, electrostatic properties and food compliance.

Coating materials

- G = G elastomer
- L = Chrome leather
- N = Novo (nonwoven polyester material)
- P = Polyamide
- R = High/Medium grip
- T = Fabric (Polyamide, Polyester, mixed)
- U = Polyurethane

Surface pattern

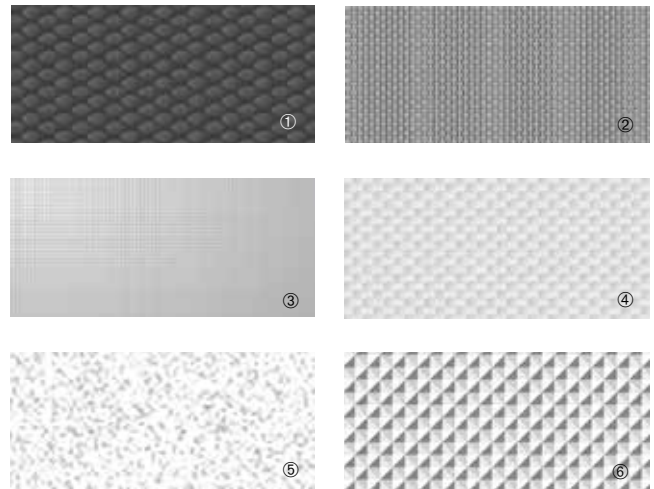

- ① FBRC fabric
- ② FSTR fine texture
- ③ GL smooth
- ④ GSTR coarse texture
- ⑤ LTHR leather
- ⑥ NP inverted pyramid texture
- ⑦ NSTR normal texture

Typical combinations

Not all combinations of tension members and coating materials are practical. Years of experience with the use of flat belts in a variety of applications have led us to offer the current combinations seen below:

Abbreviation	Product line	Tension member design	Coating
A	Aramide line	Fabric	G, U
		Cord	G, L, T
E	Polyester line	Fabric	G, N, P, R, T, U
		Cord	G, L, T, U
P	Polyamide line	Fabric	G, N, T, U
		Sheet	G, L, N, R, T, U
U	Polyurethane line	Foil	G, R, U

DESIGN AND MATERIALS

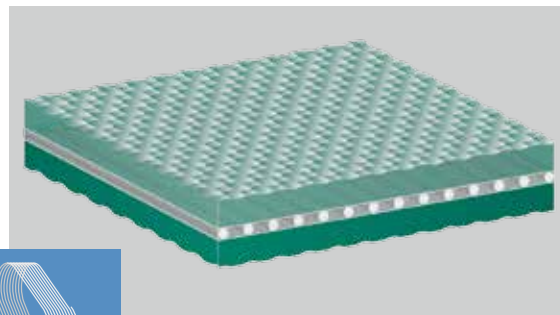
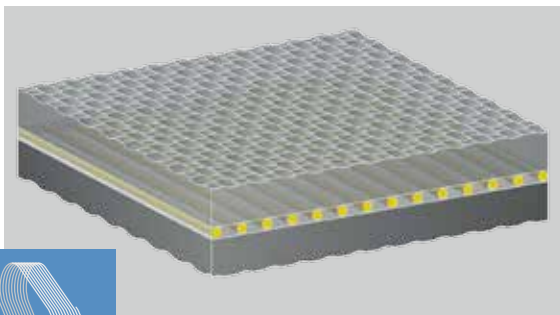
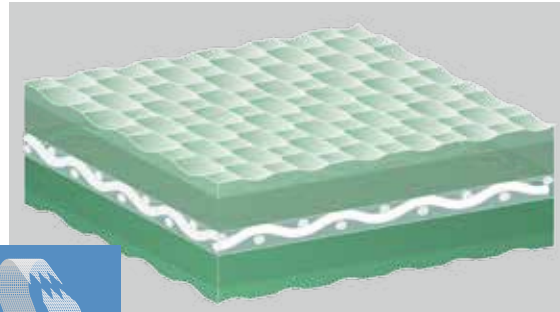
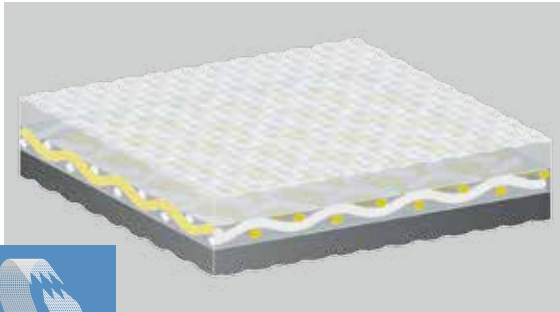

Aramide line

Flat belts with a **tension member made from mixed fabric with aramide yarn** in the direction of tension are especially flexible and extremely strong. They can be spliced directly on the machinery.

Flat belts with a **tension member made from truly endless aramide cord** have no splice to ensure particularly smooth tracking.

Siegling Extremultus flat belts of the Aramide line are designed for extremely high effective pull and extremely short take-up ranges. The aramide line must be handled with great care as the aramide fibres can easily be bent.

Polyester line

Flat belts featuring a **polyester fabric tension member** are the best choice for many applications. They are particularly flexible and strong at the same time and can be spliced on the machinery.

Flat belts with a **tension member made from truly endless polyester cord** have no splice to ensure particularly smooth tracking.

Polyester line Siegling Extremultus flat belts can transmit high circumferential forces with simultaneously short take-up ranges. In addition, they are shock-resistant and not susceptible to fluctuations in climate.

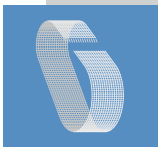
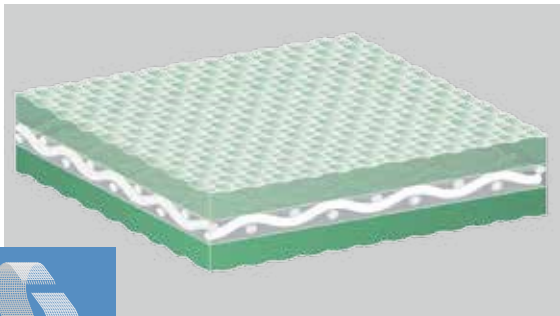
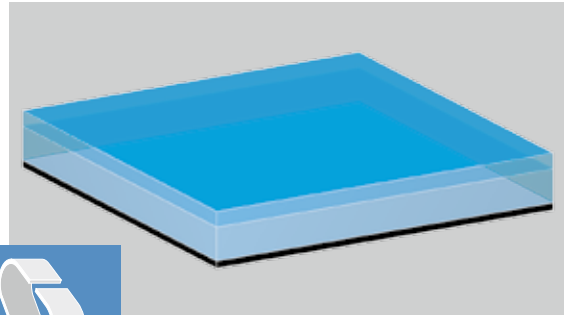
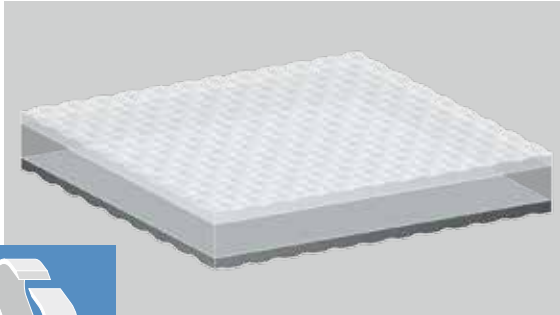

Polyamide line

Flat belts with a **tension member made from highly orientated polyamide sheet** boast particularly strong edges, are laterally stiff and durable.

Flat belts with a **polyamide fabric tension member** are especially flexible and feature relatively high tensile strength.

Polyamide is characterized by its outstanding damping capabilities. The hygroscopic properties of the polyamide material make it important to take into account extreme climatic fluctuations during storage and use.

Polyurethane line

Flat belts with a **tension member made of highly elastic polyurethane foil** are elastic, highly flexible and boast excellent damping capabilities. Due to their flexibility, Siegling Extremultus flat belts in the polyurethane line have good tracking characteristics and are particularly well suited for machinery with short center distances, manual take-up units and small drum diameters.

In addition, the polyurethane flat belts are 100% fray free and very easy to clean. That makes them perfect for use in areas where hygiene is vital.

APPLICATION GROUPS

The material and structure of the tension member as well as the coatings of the top face and underside determine the characteristic profile of each flat belt. The Siegling Extremultus range offers a wide variety of products for the application groups, including different tension members and coating variants:

- Power Transmission Belts
- Live Roller Belts
- Tangential Belts
- Drag Belts
- Folder Gluer Belts
- Machine Tapes
- Elastic Food Belts

The drive function is often mixed with sometimes extremely demanding process tasks, particularly in the last four groups. Siegling Extremultus flat belts boast versatile belt properties, perfectly supporting these processes.

Siegling Extremultus Power Transmission Belts



Siegling Extremultus Power Transmission Belts feature impressively high efficiency ($\geq 98\%$), outstanding synchronization accuracy and easy handling.

They are also characterized by:

- consistent and reliable speed and long service lives
- short take-up lines, low creep
- good damping capabilities
- durability up to a capacity of 1850 kW
- their ability to easily handle bevel and cone drives in which the belt rotates on its longitudinal axis

Typical coating combinations

- LT** = Leather underside, Fabric top face
- LL** = Leather underside and top face
- GT** = G elastomer underside, Fabric top face
- GG** = G elastomer underside and top face

Siegling Extremultus Live Roller Belts



Siegling Extremultus Live Roller Belts are energy-saving, durable drive components that ensure quick and reliable distribution.

They are also characterized by:

- durable friction layers with constant grip
- constant tension regardless of climate (aramide and polyester line)
- high flexibility and tensile strength
- low power loss due to reduced flexing force
- short downtimes due to quick installation

Typical coating combinations

- GG** = G elastomer underside and top face
- UU** = Polyurethane underside and top face
- RR** = Medium Grip underside and top face

Siegling Extremultus Tangential Belts



Siegling Extremultus Tangential Belts have been designed to suit the wide range of yarn-manufacturing processes and different drive shapes. They play a major role in ensuring consistently high yarn quality and efficient production thanks to the following characteristics:

- superior abrasion-resistant coatings made of elastomer G or polyurethane with constant friction coefficients and long service lives
- optimized surface textures for the spindle and motor side
- reduced belt slip and excellent levels of power transmission
- energy-efficient polyester or aramide tension members
- highly orientated polyamide sheet tension members with good damping capabilities
- low-noise and low-vibration operation
- antistatic finishes

Typical coating combinations

- GG** = G elastomer underside and top face
- UT** = Polyurethane underside, Fabric top face

APPLICATION GROUPS

Siegling Extremultus Drag Belts

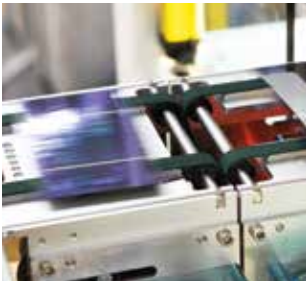

Siegling Extremultus Folder Gluer Belts



Siegling Extremultus Drag Belts are special developments with superior mechanical and electrostatic characteristics which make conveying and handling electronic components more efficient and safe:

- thanks to the HC or HC+ properties (highly conductive or highly conductive plus) the static charge that builds up in the conveyor can be discharged in a more controlled manner
- due to simplified accumulation with TT types which produce consistently low friction coefficients on the top face and underside
- due to a particularly high level of abrasion resistance, as well as stable, fray free belt edges

Typical coating combinations

TT = Fabric underside and top face

In the manufacture and processing of boxes and corrugated cardboard, **Siegling Extremultus Folder Gluer Belts** play a key role in ensuring that the quality and productivity potential of the machinery is exploited to the full. The Extremultus product range offers the right flat belt with specific characteristics for each application:

- thanks to tension-stable tension members made of polyester or aramide fabric, polyamide sheet or elastic polyurethane
- thanks to “custom grip” with a variety of surfaces that are gentle on products – also approved for direct contact with food
- thanks to constant grip and long service life

Typical coating combinations

GG = G elastomer underside and top face

RR = Medium Grip underside and top face

Siegling Extremultus Machine Tapes



Siegling Extremultus Elastic Food Belts

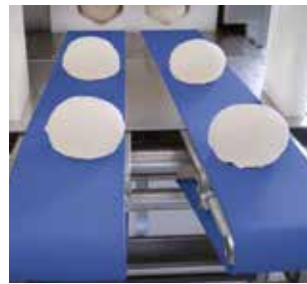

Siegling Extremultus Machine Tapes are vital components of machinery in many industrial applications. Tension members made of polyester fabric, polyamide sheet or polyurethane make them ideal for a range of different areas. Siegling Extremultus machine tapes boast:

- superior abrasion-resistant coatings with constant friction coefficients and long service lives
- surface textures and coatings, as well as electrostatic properties in keeping with requirements
- damping capability tailored to requirements (depending on the tension member)
- low elongation at fitting, low shaft load
- suitable for small drum diameters/rolling knife edges

Different coating combinations, e. g.

- GG** = G elastomer underside and top face
- TT** = Fabric underside and top face
- TG** = Fabric underside and Elastomer G top face

Siegling Extremultus Elastic Food Belts are specifically designed for applications in the food industry. The tension member is made of elastic polyurethane and is thus 100% fray free. Siegling Extremultus elastic food belts are:

- food-safe; FDA and EU compliant
- available in blue or white to optimize quality assurance (contrast to food)
- elastic and thus excellent for short center distances, belt scales and are suitable as spreading belts
- easy to clean
- chemically resistant
- available with High Grip coating

Select Siegling Extremultus elastic food belts also support the HACCP concept.

Typical coating combinations

- UU** = Polyurethane underside and top face
- UR** = Polyurethane underside, High Grip top face

MANUFACTURING TOLERANCES

As a general rule the manufacturing tolerances indicated in the following tables apply. They do not include any geometric changes that may occur following manufacture as a result of climatic fluctuations or other external influences.

In some cases, special tolerances are also possible upon request. Please contact your local representative:
www.forbo.com/movement > Contact

Length tolerances

Polyester line and Aramide line (fabric)	
300 – 5000 mm	± 0.30 %
5001 – 15000 mm	± 0.20 %
> 15000 mm	± 0.15 %
Polyester line and Aramide line (cord)	
500 – 1000 mm	± 0.50 %
1001 – 5000 mm	± 0.40 %
> 5000 mm	± 0.30 %
Polyamide line (sheet and fabric)	
300 – 5000 mm	± 0.50 %
5001 – 15000 mm	± 0.30 %
> 15000 mm	± 0.20 %
Polyurethane line	
300 – 5000 mm	± 0.30 %
5001 – 15000 mm	± 0.20 %
> 15000 mm	± 0.15 %

Width tolerances

Polyester line and Aramide line (fabric)	
10 – 120 mm	+ 0.2/– 0.3 mm
121 – 500 mm	± 1.5 mm
> 500 mm	± 5.0 mm
Polyester line and Aramide line (cord)	
20 – 50 mm	± 1.0 mm
51 – 100 mm	± 1.5 mm
101 – 250 mm	± 2.0 mm
> 250 mm	± 3.0 mm
Polyamide line (sheet and fabric)	
10 – 50 mm	± 1.0 mm
51 – 120 mm	± 2.0 mm
121 – 500 mm	± 3.0 mm
501 – 1000 mm	± 10.0 mm
Polyurethane line	
10 – 120 mm	+ 0.2/– 0.3 mm
121 – 500 mm	± 1.5 mm
> 500 mm	± 5.0 mm

Thickness tolerances

Siegling Extremultus flat belts can have different thickness tolerances depending on the combination of tension member and coating material. Please always observe the information on the respective data sheets.

Tolerances for perforations

All lines	
Diameter of hole	± 0.5 mm
Spacing between holes	± 1.0 mm

DELIVERY DIMENSIONS

Siegling Extremultus products are produced in large widths and extremely long lengths of roll material. The products can then be delivered in different, customer-specific ways, depending on production or standard delivery dimensions.

Available as

All Siegling Extremultus flat belts, except for those with tension members made of truly endless cord, can be delivered in the following three forms:

- open, as roll material
- prepared for on-site installation in the following variants
 - cut at 90° or 60° angles
 - prepared for being made endless on one side
 - prepared for being made endless on both sides
- endless, spliced and ready to install (even flat belts with tension members made of endless cord)

Please contact your local representative for more information about the delivery forms available:

www.forbo.com/movement >

Contact

We will be delighted to help.

How to measure order length

When ordering flat belts spliced endless, the length is measured inside, i.e. on the underside.

To do this, place the flat belt on its edge, affix a steel tape firmly on its inside (Fig. 1) or measure directly over the pulleys (Fig. 2).

If your machinery has a take-up unit, it should be adjusted to determine the order length as shown in figure 3.

The order length should be determined when the take-up unit is in the zero position. We recommend selecting a zero position for the take-up unit that enables a take-up line greater than the path required to apply the elongation at fitting. In addition, it should be possible to have a return distance from the zero position that is greater than the minus tolerance when manufacturing the belt.

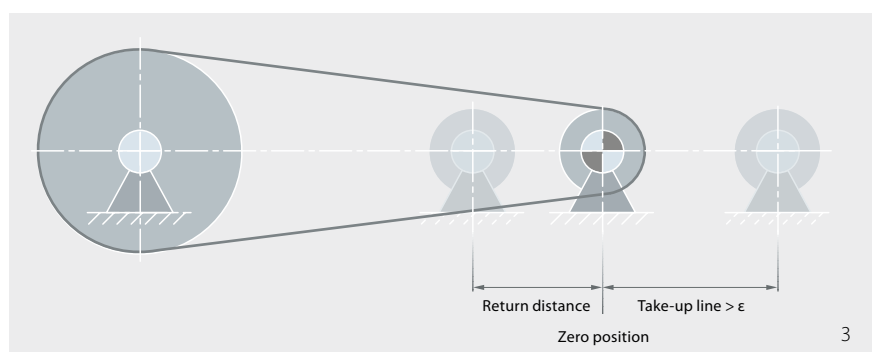
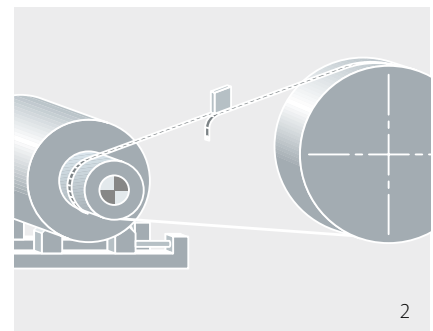
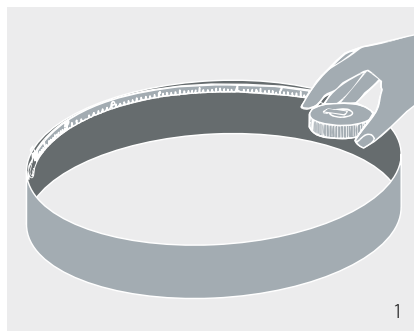

Siegling – total belting solutions

Committed staff, quality oriented organization and production processes ensure the constantly high standards of our products and services.

Forbo Movement Systems complies with total quality management principles. Our quality management system has ISO 9001 certification at all production and fabrication sites. What's more, many sites have ISO 14001 environmental management certification.



Ref. no. 225-2
11/22 - UDH - Reproduction of text or parts thereof only with our approval. Subject to change.



Our service – anytime, anywhere

Forbo Movement Systems employs around 2,500 people in its group of companies. Our products are manufactured in ten production facilities across the world.

You can find companies and agencies with warehouses and workshops in over 80 countries.

Service points are located in more than 300 places worldwide.

Forbo Siegling GmbH

Lilienthalstrasse 6/8, D-30179 Hannover

Phone +49 511 6704 0

www.forbo-siegling.com, siegling@forbo.com



MOVEMENT SYSTEMS