

PVC TO BE GLUED

ACCESSORIES DATA SHEET

ADHESIVES

MANDATORY

	Adhesives	Weight	Consumption /m ²	Spreader	Waiting time	Opening time	Observation
Sarlon Traffic Sarlon Habitat Sarlon Primeo Eternal Surestep / Safestep Sphera	522 Eurosafe Tack	13 kg	250 g	A2	20 min	90 min	522 for all PVC floor and wall sheet ranges, heat reactivatable.
	622 Eurostar Tack					60 min	622 is a more ecological version of the 522.
	528 Eurostar All Round	13 kg	250 g	A2	15 min	40 min	Multi-purpose EC1 construction adhesive.
	644 Eurostar Multi Plus	12 kg	190 - 270 g	A1/A2	10 min	60 min	Fiber-reinforced universal adhesive, GREEN (EC1+), high performance.
Sarlon Complete Step	840 Eurotape Doubletack	Dimensions : 50mmx50m 90mmx50m 240mmx25m	0,5 mt				Double-sided adhesive tape with elastic, dimensionally stable woven backing, very high initial and final adhesion.
	650 Eurostar Fastcol	7,5 kg	500 g	Tools included	1-2 hrs	4 hrs	GREEN (EC1+) technical contact adhesive, heat reactivatable.
Specific Subfloors High traffic	140 Euromix PU	13.4 kg	450-650 g	A2			Two-component, PU-based adhesive for specific subfloors, GREEN (EC1+)

PVC TO BE GLUED ACCESSORIES DATA SHEET

WELDING **IMPORTANT**

PVC WELDING ROD

Ref. : floorcovering ref

*Sphera welding rods are available in Uni and Multicolor.

Welding allows the junction between strip edges.

Achieves E2/E3 rating with PVC.

A groove is formed, and the weld is then applied using a hot air gun fitted with a PVC fast-welding nozzle.

Coil of 50 m (Sarlon - Surestep – Eternal -Sphera)



Labelling found on each PVC welding rod

Estimated consumption of welding rod :
Strip coverings without skirting : approx.0.75 m/m².
Strip coverings with skirting : approx.1 m/m².

Welding rod box number

228	VINYLWELD	
↔	50 m Ø 4 mm	# 7712105
	433121, 40392	

Commercial reference of PVC floorcovering corresponding with this welding rod

PROFILES

IMPORTANT

Cove former

Ref. : 3009 blanc / 3109 noir / 3209 noir

- 3009 = 15 x 15 : this profile is used vertically in internal corner to that the wall covering matches corners perfectly.
- 3109 = 20 x 20 : this profile is used at the bottom of partitions. Provides backing for the flooring to rise with a rounded profile, thus making corners last longer and improving aesthetics, while preventing perforation.
- 3209 = 25 x 25 : same using as the 20x20 profile but appropriate for more rigid floorcovering.

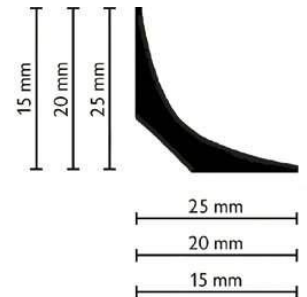

Box of 20 lengths of 2,5 m namely 50 m/box

PVC capping profile EL3.5

Ref. : XXXXEL3.5

PVC capping strip is the right finishing profile when you would like to have a perfect finishing with coving installation. Ideal for PVC floorcovering.

Box of 25 lengths of 2,5 m namely 62.5 m / box

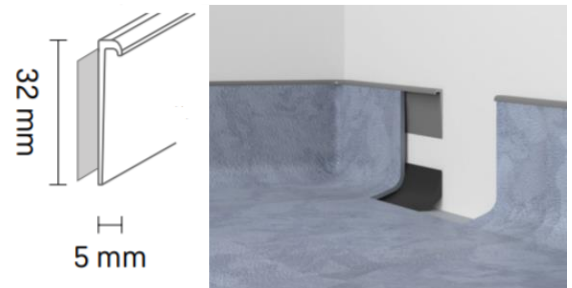

0110 - noir



0146 - gris foncé



1137 - blanc



0132 - brun



0130 - beige



0138 - gris clair

Stairnosing to install before and after floorcovering

Phosphorescent PVC step nose with structured support surface to be implemented before (****TF) or after (****TJ) the flooring is laid.

Box of 10 lengths of 2,5 m namely 25 m/box

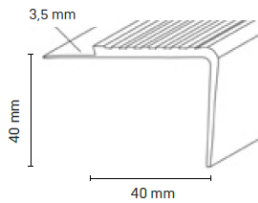
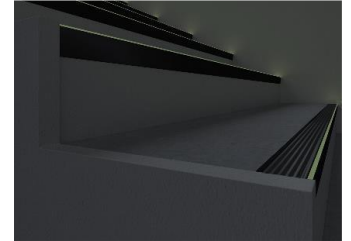

****TF (before)

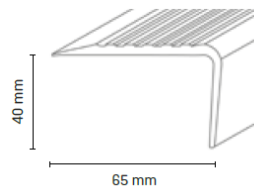

****TJ (after)

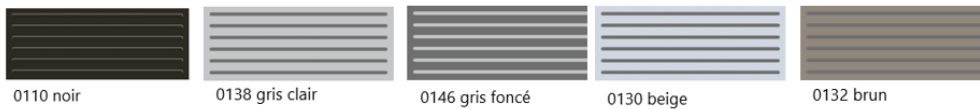

SKIRTINGS AND CORNERS

SUGGESTED

Soft complete skirting for old and new support

Flexible finishing profile for corner support and finishing. Its flexibility makes it suitable for both new and old substrates.

Box of 20 lengths of 2.5 m namely 50 m/box

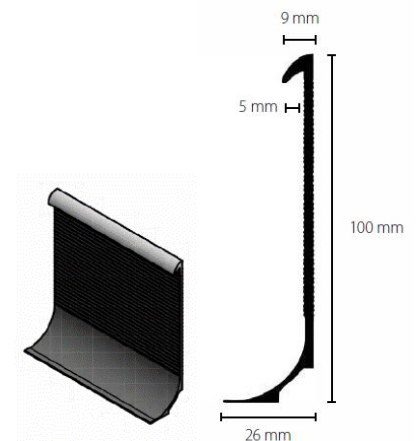

Decorative skirting

Semi rigid PVC skirting available in 3 heights : 60, 80 and 100 mm.

- In 60 mm, they are mainly proposed for residential and for places with low and medium traffic areas.
- In 80 mm, they are used in renovation to replace old skirtings with a lower height.
- In 100 mm, they are recommended for schools and hospitals.

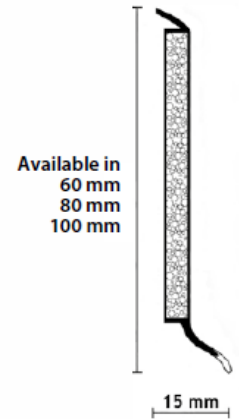

Box of 20 lengths of 2.5m namely 50m/box

Please indicate, during your order, the height requested with the reference.

Example : 1940 - 80 (white color 1940 in 80 mm height)



1940
BLANC



2250
NOIR



4000
GRIS CLAIR



4005
TAUPE



5005
TABAC



6050
TAUPE FONCE



6500
GRIS FONCE

PVC recover skirting

Solid-colored rigid PVC skirting.

Especially designed to adapt to different skirting thicknesses and heights.

- up to 14 mm of thickness
- up to 100 mm in height (two parts, each 20 mm long, can be broken off).

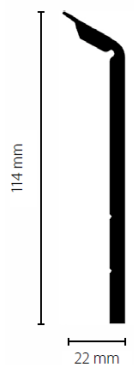

Box of 20 lengths of 2,5 m namely 50 m/box



1940PAR
Blanc



4005PAR
Taupe clair



6500PAR
Gris foncé

HDF CUBU 80 skirting

Ref. : ****CU80

HDF skirting coated with chlorine-free Polyblend, PP / TPE base, with flexible lips on floor and wall. Straight edge finish.

- Soft lips on wall and floor
- Robust surface
- Mitre tool cut-outs, without pre-formed accessories

Box of 10 lengths of 2,5 m namely 25 m per box



1132 - blanc



1209 - gris anthracite

Inner & outer preformed corner Sphera Element

Ref. : Inner or outer corner available under the floor reference wish

Enables the creation of inner and outer corners.

Inner dimension : Height 10 cm (wall) / width 5 cm (floor) / 16 cm of width

Outer dimension : Height 10 cm (wall) / width 5 cm (floor) / 12 cm of width

The installation has to be done with an acrylic adhesive type 522 Eurosafe Tack or 622 Eurostar Tack.

Box of 10 pieces

