

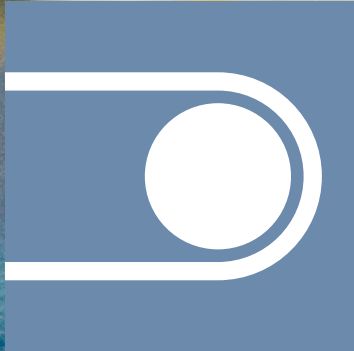

**siegling extremultus**  
flat belts

# COMPENDIUM FLAT BELTS





|          |  |           |
|----------|--|-----------|
| <b>1</b> | <b><u>Siegling – total belting solutions</u></b> .....   | <b>5</b>  |
| 1.1      | <u>Company and group</u> .....                           | 6         |
| 1.2      | <u>Products and markets</u> .....                        | 7         |
| <b>2</b> | <b><u>Siegling Extremultus flat belts</u></b> .....      | <b>9</b>  |
| 2.1      | <u>History of flat belts</u> .....                       | 10        |
| 2.2      | <u>Design and materials</u> .....                        | 16        |
| 2.3      | <u>Electrostatic properties</u> .....                    | 20        |
| 2.4      | <u>Food properties</u> .....                             | 22        |
| 2.5      | <u>Nomenclature and Datasheet</u> .....                  | 23        |
| 2.6      | <u>General properties of force-fit belt drives</u> ..... | 24        |
| 2.7      | <u>Force-fit belt drives in comparison</u> .....         | 26        |
| 2.8      | <u>Special strengths of flat belts</u> .....             | 28        |
| 2.9      | <u>Application groups</u> .....                          | 30        |
| <b>3</b> | <b><u>Chemical resistance</u></b> .....                  | <b>35</b> |
| 3.1      | <u>General information</u> .....                         | 36        |
| 3.2      | <u>Chemical resistance</u> .....                         | 37        |
| <b>4</b> | <b><u>Belt selection</u></b> .....                       | <b>41</b> |
| 4.1      | <u>General information</u> .....                         | 42        |
| 4.2      | <u>Tension member</u> .....                              | 43        |
| 4.3      | <u>Coating materials</u> .....                           | 44        |
| 4.4      | <u>Extremultus Product Finder</u> .....                  | 46        |
| 4.5      | <u>B_Rex Calculator</u> .....                            | 47        |
| <b>5</b> | <b><u>Manufacturing data</u></b> .....                   | <b>49</b> |
| 5.1      | <u>Manufacturing tolerances</u> .....                    | 50        |
| 5.2      | <u>Delivery dimensions</u> .....                         | 51        |

|          |  |           |           |  |            |
|----------|--|-----------|-----------|--|------------|
| <b>6</b> | <b><u>Handling flat belts</u></b> .....                                  | <b>53</b> | <b>10</b> | <b><u>Calculation of Live Roller Belts</u></b> ..... | <b>99</b>  |
| 6.1      | <u>Storage</u> .....   | 54        | 10.1      | <u>General information</u> .....                     | 100        |
| 6.2      | <u>Condition of machinery</u> .....                                      | 55        | 10.2      | <u>Terminology</u> .....                             | 101        |
| 6.3      | <u>Fitting and tensioning</u> .....                                      | 56        | 10.3      | <u>Calculation method</u> .....                      | 102        |
| 6.4      | <u>Maintenance and handling</u> .....                                    | 63        | <b>11</b> | <b><u>Troubleshooting</u></b> .....                  | <b>107</b> |
| <b>7</b> | <b><u>Splicing and fabrication technology.</u></b> .                     | <b>65</b> | 11.1      | <u>Installation</u> .....                            | 108        |
| 7.1      | <u>General information</u> .....   | 66        | 11.2      | <u>Splice opening</u> .....                          | 109        |
| 7.2      | <u>Splice types</u> .....  | 67        | 11.3      | <u>Noise generation</u> .....                        | 110        |
| 7.3      | <u>Splicing</u> .....  | 70        | 11.4      | <u>Poor belt tracking</u> .....                      | 111        |
| 7.4      | <u>Fabrication options</u> .....   | 72        | 11.5      | <u>Wear</u> .....                                    | 113        |
| <b>8</b> | <b><u>Pulleys</u></b> .....  | <b>75</b> | 11.6      | <u>Changes in properties</u> .....                   | 115        |
| 8.1      | <u>Pulley geometries</u> .....   | 76        | <b>12</b> | <b><u>Glossary</u></b> .....                         | <b>117</b> |
| 8.2      | <u>Dimensions and quality of pulleys</u> .....                           | 78        | <b>13</b> | <b><u>Legal notes</u></b> .....                      | <b>126</b> |
| 8.3      | <u>Use of crowned pulleys</u> .....                                      | 79        |           |  |            |
| <b>9</b> | <b><u>Calculation of power transmission belts</u></b> .....              | <b>81</b> |           |  |            |
| 9.1      | <u>General information</u> .....   | 82        |           |  |            |
| 9.2      | <u>Power transmission on flat belts</u> .....                            | 83        |           |  |            |
| 9.3      | <u>Terminology</u> .....   | 84        |           |  |            |
| 9.4      | <u>Calculation method</u> .....  | 85        |           |  |            |
| 9.5      | <u>Operating factor <math>c_2</math></u> .....                           | 86        |           |  |            |
| 9.6      | <u>Basic elongation at fitting <math>c_4</math></u> .....                | 87        |           |  |            |
| 9.7      | <u>Elongation allowance for centrifugal force <math>c_5</math></u> ..... | 92        |           |  |            |
| 9.8      | <u>Vibration calculation</u> .....                                       | 94        |           |  |            |
| 9.9      | <u>Calculation example</u> .....   | 96        |           |  |            |

Not always visible, yet present everywhere, Forbo Movement Systems makes sure that your logistics and production workflow run smoothly and optimally. Our solutions are characterized by a high level of efficiency, precision and reliability. We are in global demand as an expert partner in the development of industry-specific and future-oriented solutions for drives, conveyor systems and manufacturing.

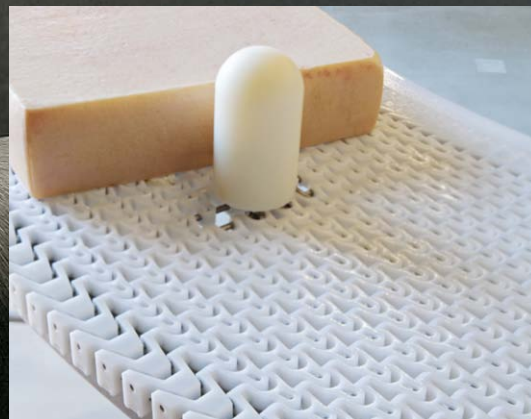



# 1 SIEGLING – TOTAL BELTING SOLUTIONS

- 1.1 [Company and group](#)
- 1.2 [Products and markets](#)

# 1.1 COMPANY AND GROUP

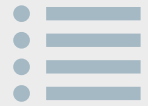

Forbo Movement Systems is a division of Forbo Holding AG. The company's headquarters is located in Baar, Switzerland, in the Canton of Zug. The company is listed on the SIX Swiss Exchange. Forbo is a global player whose two divisions, Forbo Flooring Systems and Forbo Movement Systems, serve a wide variety of industries and markets.

The Movement Systems division has risen to a leading position worldwide as a provider of high-quality conveyor and processing belts, plastic modular belts, first-class power transmission belts and both toothed and flat belts made of synthetic materials. These belts are used in a wide variety of

applications in both industry and commercial enterprises and service companies, for instance as conveyor and processing belts in the food industry, as treadmills in gyms or as flat belts in letter sorting systems.

Movement Systems employs more than 2500 people and has an international network of companies and representatives with materials warehouses and workshops in over 80 countries.



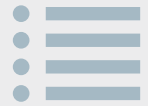

The increasing globalization of markets requires an innovative approach to production, materials flow and logistics; conveyor belts, processing belts and power transmission belts often play a key role in this process. We keep the world running with these products.

## Our products

### **siegling transilon** conveyor and processing belts

... are multi-layered and fabric-based belts, or belts made from homogeneous materials. They ensure efficient materials flow and economical process flows in all areas of light conveyor technology.

### **siegling transtex** conveyor belts

... are multi-layered, fabric-based belts with a particularly robust design, and are therefore the preferred solution for heavy-duty conveying.

### **siegling extremultus** flat belts

... are multi-layered and fabric-based power transmission belts, or belts made from homogeneous materials. When used for power transmission and conveying, they optimize power transmission and numerous production processes.

### **siegling prolink** modular belts

... are plastic modules connected by hinge pins and with various designs. They are often ideal for combining conveying and processing.

### **siegling proposition** timing belts

... are form-fit belts made from homogenous plastics and with various tension members; they are perfect for challenging acceleration, timing and positioning processes.

## Our main markets are

- Food industry
- Logistics, airports
- Industrial production
- Raw materials
- Textile industry
- Paper industry
- Printing industry
- Sport and leisure
- Tobacco industry
- ▶ Food processing, agriculture and packaging sectors
- ▶ Intralogistics, distribution centers, baggage sorting
- ▶ Automotive, tires, chemicals, energy, steel- and metalworking industries
- ▶ Building materials, wood and stone
- ▶ Yarn manufacturing, nonwovens, textile printing
- ▶ Paper production and processing as well as letter sorting
- ▶ Rotary printing, sheet-fed printing, digital printing and post-press
- ▶ Treadmill belts, belts for ski lifts and other leisure activities
- ▶ Raw tobacco and cigarette manufacturing







# 2 **SIEGLING** **EXTREMULTUS** FLAT BELTS

- 2.1 [History of flat belts](#)
- 2.2 [Design and materials](#)
- 2.3 [Electrostatic properties](#)
- 2.4 [Food properties](#)
- 2.5 [Nomenclature and Datasheet](#)
- 2.6 [General properties of force-fit belt drives](#)
- 2.7 [Force-fit belt drives in comparison](#)
- 2.8 [Special strengths of flat belts](#)
- 2.9 [Application groups](#)

# 2.1 HISTORY OF FLAT BELTS

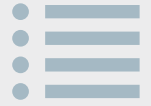

## The industrial revolution

In pre-industrial times, the forces of nature were harnessed using axles, gears and drive mechanisms like chains and ropes. Normally, a connection was established between the generator and a single consumer: from the windmill vane to the grindstone, from the draft animal to the scoop wheel, from the water wheel to the forging hammer. This principle endured for thousands of years – until, completely independent of wind energy or hydropower, the steam engine offered such great mechanical power on demand that many consumers could be supplied at the same time.

At the time of their invention at the beginning of the 18th century, the first steam engines were still very inefficient. It wasn't until 1769 when James Watt patented his invention of the double-acting piston, increasing efficiency tremendously. During the course of the 19th century, efficiency continued to improve thanks to a number of inventions, designs became more compact and use became more effective. The spread of the steam engine sparked the industrial revolution in the factories. With its triumph, the flat belt appeared confidently on the scene. Individual production machines were driven by steel shafts on the hall ceiling, pulleys and flat transmission belts made of leather.

Transmission belts were the simple and reliable link between the steam engine and the new mechanical inventions of the time: e.g. machine tools, spinning machines and mechanical looms.

Flat belts were used for power transmission well into the 20th century, even for agricultural machinery and vehicles (the first ones were operated with steam engines).



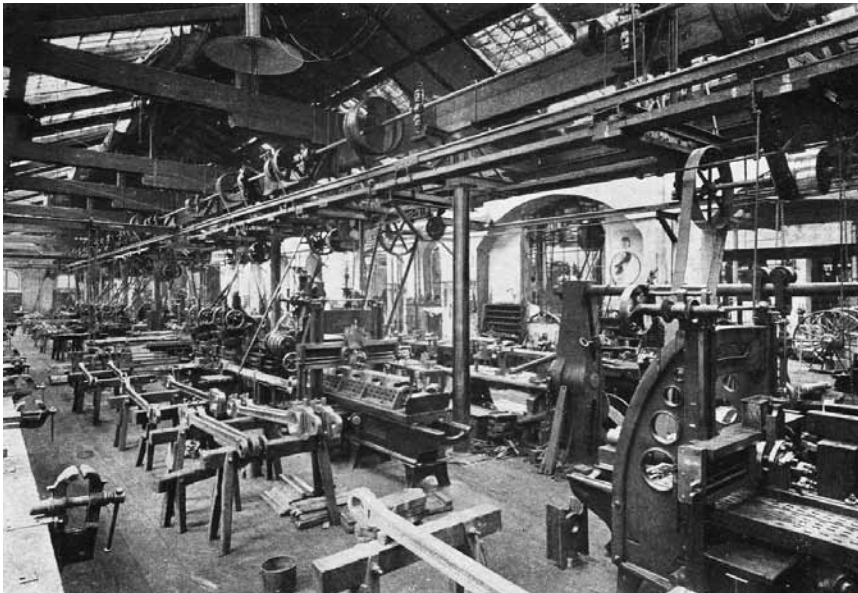
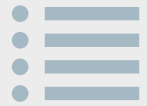

Production building 1906.  
Each of the processing machines is driven by a central transmission shaft underneath the building's ceiling.

## Siegling shapes flat belt development

In 1919 Ernst Siegling founded a transmission belt factory in his name in Hanover and shortly thereafter began producing flat belts made of leather.

At the start of the 1920s, he helped with the breakthrough of a new flat belt design: the upright chrome leather belt. Upright leather belts were con-

nected crossways to the direction of movement using rivet pins. This made the belt particularly robust, even and efficient. With lower shaft loads it offered higher power transmission and less slip.

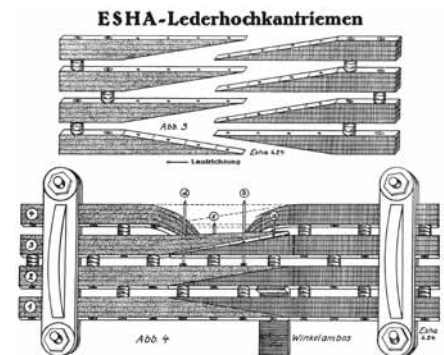

Above:  
Design of the chrome leather upright belt (illustration from 1925).

On the right:  
Ernst Siegling

On the left:  
Ernst Siegling with some of his workforce in the 1920s.



## 2.1 HISTORY OF FLAT BELTS

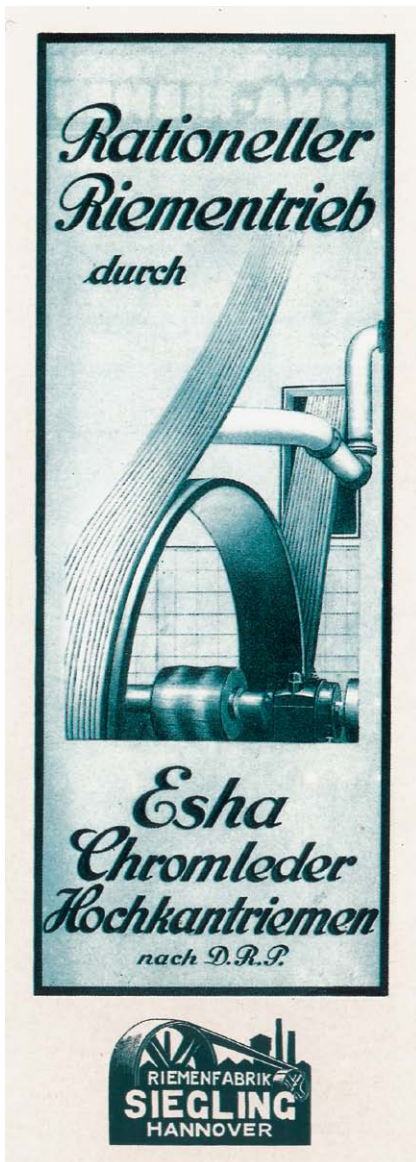

However, the disadvantages of natural leather were still evident: leather stretches over time which means that the belts have to be shortened at regular intervals. On top of that, the belts were not particularly dimensionally stable and were sensitive to moisture. At the same time, industrial buyers were becoming more demanding in terms of their technical requirements. The advent of motors increasingly suppressed energy distribution via transmissions and single drive tool machines became the norm. Flat belts were now in stiff competition with other transmission variants.

Ernst Siegling continued to consistently develop his range of flat belts. The beginning of the 1930s saw the introduction of the first flat belts with adhesive coatings and in 1939 the first electrically conductive belts for hazardous areas followed under the name "non-el-stat".



The development of a multi-layered polyamide and chrome leather flat belt at the beginning of the 1940s was a technical milestone. A highly orientated polyamide sheet served as the tension member and a thin chrome leather layer as the surface. This belt construction combined the advantages of both materials and is still widely used today. Boasting at least 98% efficiency, this construction represented a significant increase in energy efficiency compared to conventional belt and chain drives. This development was patented in 1943, launched on the market as Extremultus and sold all over the world from the late 1940s.



**Siegling-Riemen**

**Sieglingriemen**  
H A N N O V E R

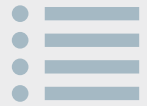

Ernst Siegling died in 1954, whereupon his son Hellmut Siegling took over the company and successfully carried on the concept of the multi-layered flat belt. In addition to the tried and true polyamide band, a variety of other

fabric tension members came into use. The chrome leather coating also underwent numerous changes. Diversification led to the creation of new products that have since become indispensable to a variety of industrial

sectors. Even the development of a fabric-based plastic conveyor for internal materials flow (Transilon) in the 1960s, groundbreaking at the time, was based on years of experience and knowledge of flat belts.



**Sieglingriemen** EXTREMULTUS

Der patentierte  
**FLACH-RIEMEN**  
aus Kunststoff und Leder



MOVEMENT SYSTEMS

# 2.1 HISTORY OF FLAT BELTS

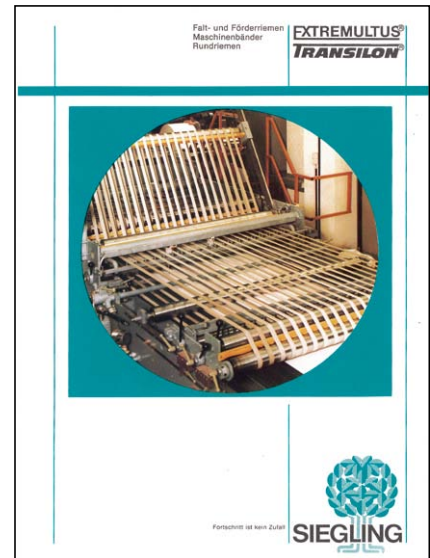
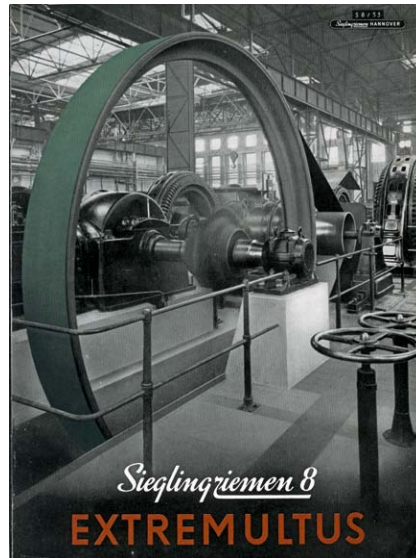
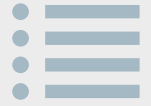

In 1994, the Forbo Beteiligungs GmbH took over the shares previously owned by the family. The company continued on its path to globalism, adding new production and assembly sites in countries including China. Rigorous research and development work drove the development of flat belts that perfectly supported produc-

tion processes while performing their function as drive elements. Siegling Extremultus flat belts are prime examples of this, boasting outstanding grip for converting paper and cardboard (Grip Star™) as well as belts for electrostatic discharge (ESD) areas in the electronics industry (Flash Star™).

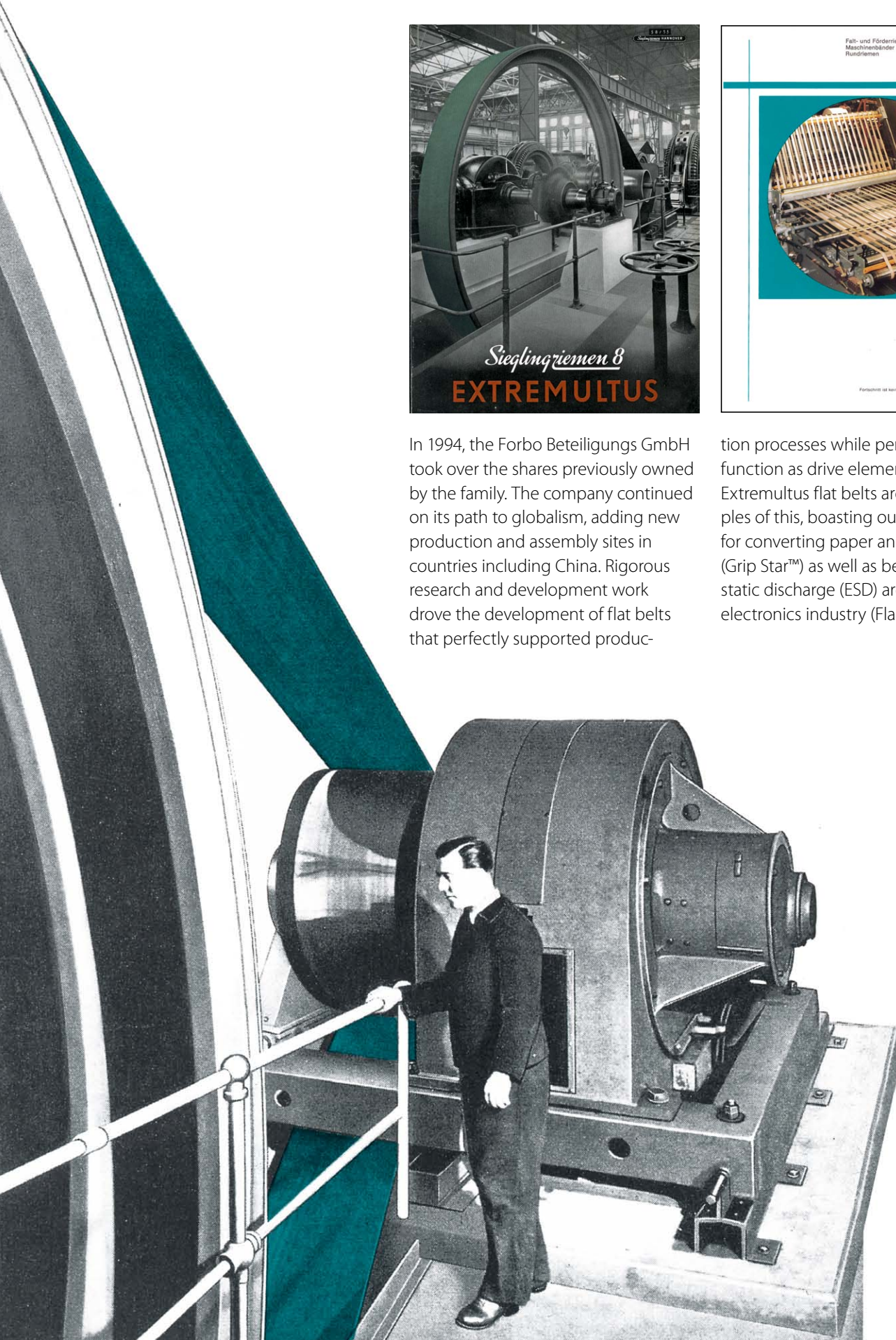

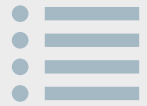

## Flat belts today

Today's descendants of the old transmission belts are high-tech products that contribute significantly when it comes to efficient and smooth operation in a wide variety of industrial drive and production processes. Their rapid evolution and the state of their development today are evident in their impressive key data:

### Tensile strength

The tensile strength increased from 30 N/mm<sup>2</sup> for core leather belts to approx. 500 N/mm<sup>2</sup> for flat belts with a polyamide tension member. Today, values of approx. 800 N/mm<sup>2</sup> are easily achieved when polyester materials are used. This type of improvement meant that considerably more compact, more cost-effective belt drives were inevitable. The power transmitted per mm of belt width is approx. 30–40 kW/mm, assuming good operating conditions and corresponding belt speeds.

### Belt speed

The maximum belt speed for core leather belts topped out at approx. 35 m/s. With the belt constructions common today, speeds up to 100 m/s are not uncommon. Speeds of up to 200 m/s can be achieved on engine test stations over a prolonged period of time. Siegling Extremultus flat belts with tension members made of endless cord without splicing are used in such cases.

### Bending frequencies

Core leather belts were limited to approx. 40 bending cycles per second. Today, Siegling Extremultus flat belts with tension members made of endless cord (polyester cord) allow approx. 250 bending cycles per second without limiting service life.

### No maintenance or re-tensioning

The materials used as tension members today (polyamide, polyester and aramide) retain tension following relaxation, eliminating the need for re-tensioning or shortening the Siegling Extremultus flat belts during operation. Effective material combinations consisting of plastic tension members and elastomer coatings require no maintenance. Only flat belts with chrome leather coatings must be maintained at certain intervals. However, a special spray makes maintenance extremely easy and clean.

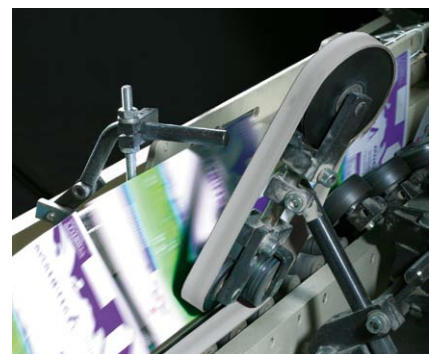

## 2.2 DESIGN AND MATERIALS

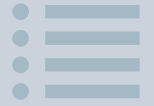

Structural diagram of a flat belt

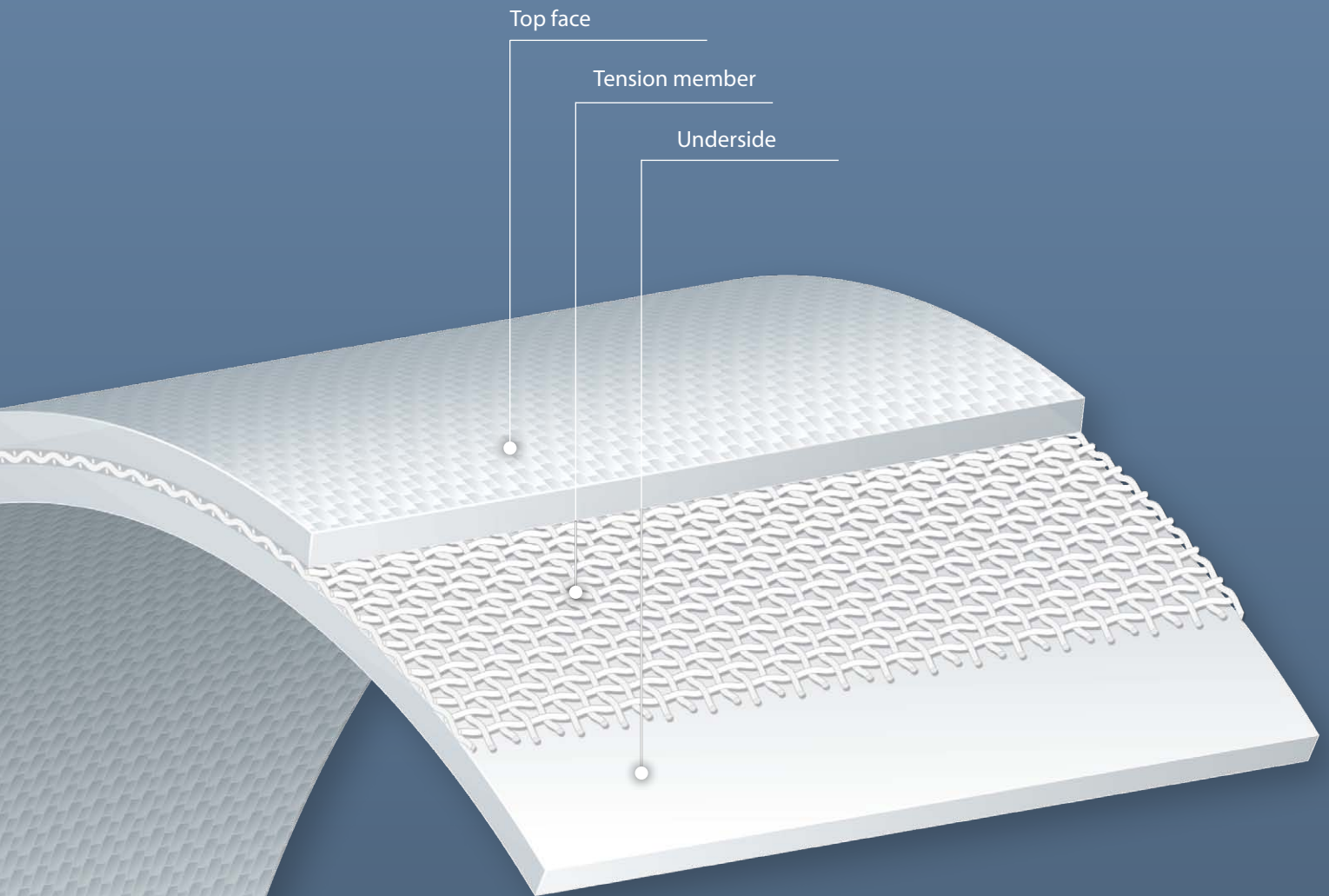

### Tension member design

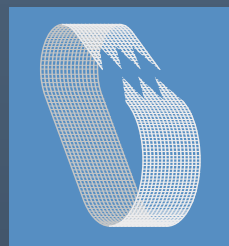

Fabric in warp and weft



Sheet (highly oriented)  
or Foil (elastic)

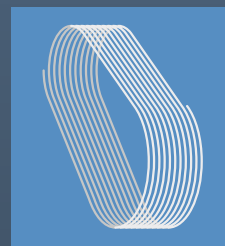

Truly endless cord



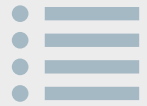

The diagram (page 16) depicts the construction of a flat belt made up of a tension member as well as coatings on the top face and the underside. Depending on the choice of material and the sub-type etc., flat belts have very different properties, making them suitable for a wide variety of applications.

## Tension member

The technical properties of a flat belt are primarily determined by its tension member. For this reason, Siegling Extremultus flat belts with the same tension member materials are grouped in product lines.

### Tension member materials

- A = Aramide line
- E = Polyester line
- P = Polyamide line
- U = Polyurethane line

## Coating

The coatings are in direct contact with the drive pulleys (generally the underside of the belt) and, where necessary, with the product to be conveyed (generally the top face of the belt). Skillful selection of the material and surface pattern make it possible to determine contact-specific properties such as grip, chemical resistance, electrostatic properties and food compliance.

### Coating materials

- G = G elastomer
- L = Chrome leather
- N = Novo (nonwoven polyester material)
- P = Polyamide
- R = High/Medium grip
- T = Fabric (Polyamide, Polyester, mixed)
- U = Polyurethane

## Surface pattern

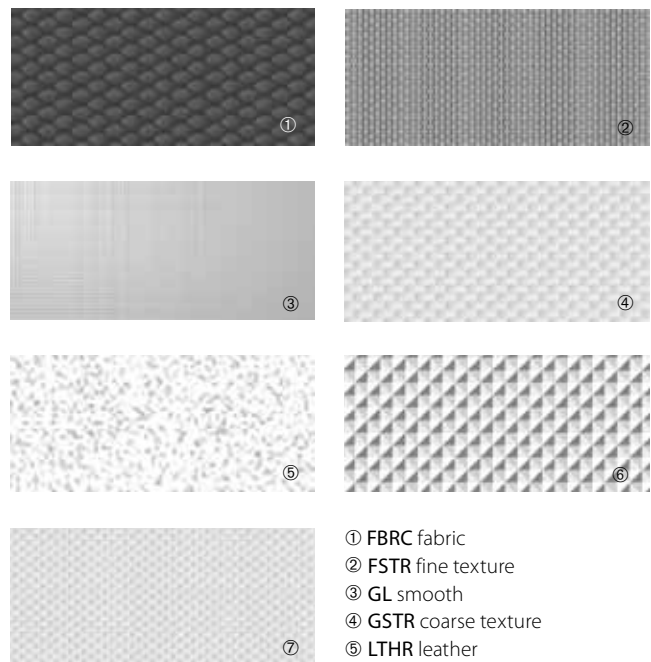

- ① FBRC fabric
- ② FSTR fine texture
- ③ GL smooth
- ④ GSTR coarse texture
- ⑤ LTHR leather
- ⑥ NP inverted pyramid texture
- ⑦ NSTR normal texture

## Typical combinations

Not all combinations of tension members and coating materials are practical. Years of experience with the use of flat belts in a variety of applications have led us to offer the current combinations seen below:

| Abbreviation | Product line      | Tension member design | Coating          |
|--------------|-------------------|-----------------------|------------------|
| A            | Aramide line      | Fabric                | G, U             |
|              |                   | Cord                  | G, L, T          |
| E            | Polyester line    | Fabric                | G, N, P, R, T, U |
|              |                   | Cord                  | G, L, T, U       |
| P            | Polyamide line    | Fabric                | G, N, T, U       |
|              |                   | Sheet                 | G, L, N, R, T, U |
| U            | Polyurethane line | Foil                  | G, R, U          |

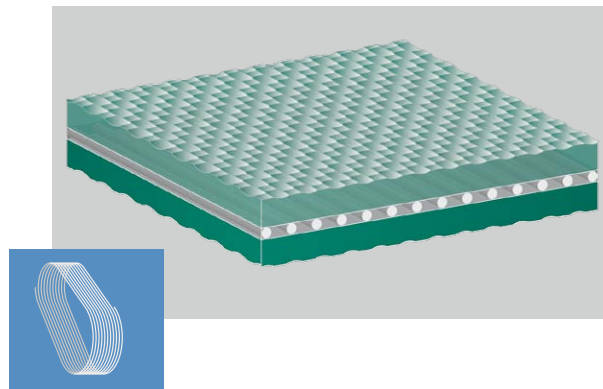
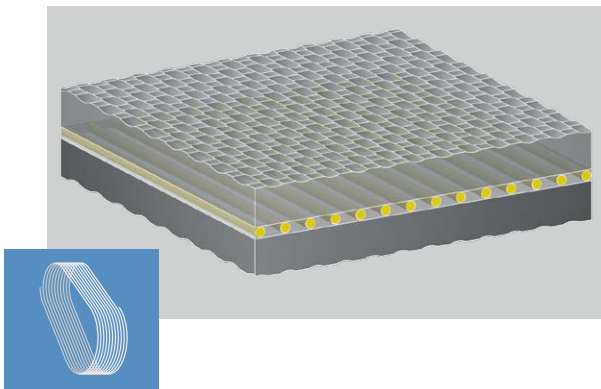
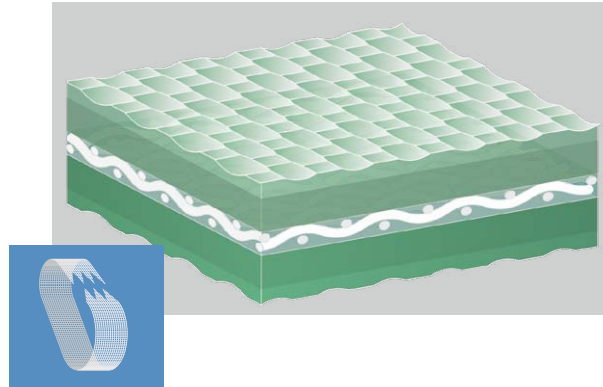
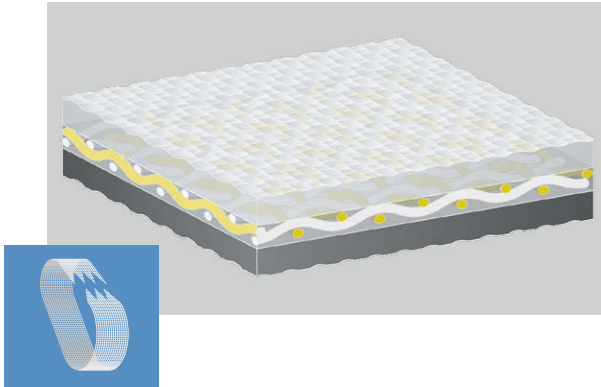

### Aramide line

Flat belts with a **tension member made from mixed fabric with aramide yarn** in the direction of tension are especially flexible and extremely strong. They can be spliced directly on the machinery.

Flat belts with a **tension member made from truly endless aramide cord** have no splice to ensure particularly smooth tracking.

Siegling Extremultus flat belts of the Aramide line are designed for extremely high effective pull and extremely short take-up ranges. The aramide line must be handled with great care as the aramide fibres can easily be bent.

### Polyester line

Flat belts featuring a **polyester fabric tension member** are the best choice for many applications. They are particularly flexible and strong at the same time and can be spliced on the machinery.

Flat belts with a **tension member made from truly endless polyester cord** have no splice to ensure particularly smooth tracking.

Polyester line Siegling Extremultus flat belts can transmit high circumferential forces with simultaneously short take-up ranges. In addition, they are shock-resistant and not susceptible to fluctuations in climate.

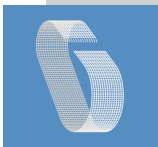
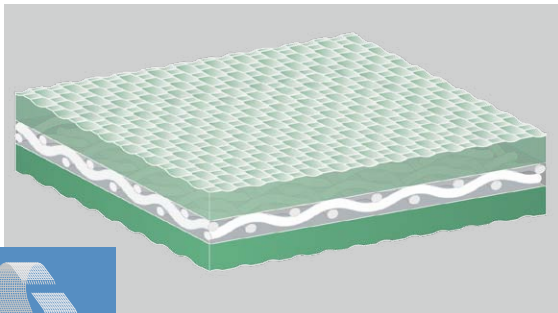
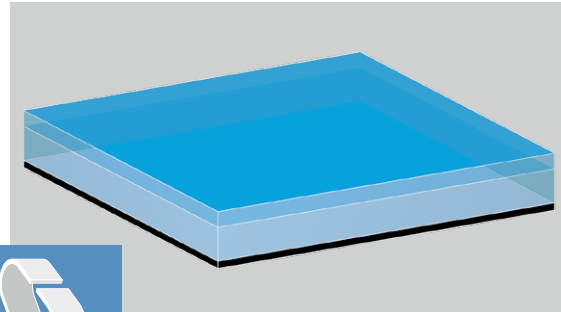
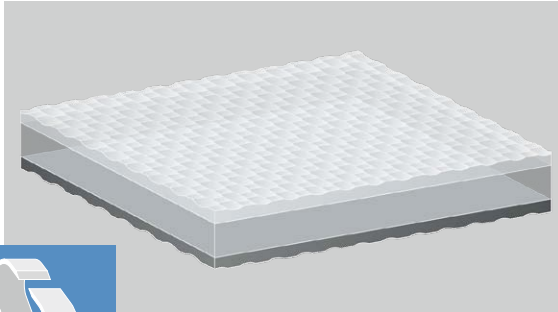

## Polyamide line

Flat belts with a **tension member made from highly orientated polyamide sheet** boast particularly strong edges, are laterally stiff and durable.

Flat belts with a **polyamide fabric tension member** are especially flexible and feature relatively high tensile strength.

Polyamide is characterized by its outstanding damping capabilities. The hygroscopic properties of the polyamide material make it important to take into account extreme climatic fluctuations during storage and use.

## Polyurethane line

Flat belts with a **tension member made of highly elastic polyurethane foil** are elastic, highly flexible and boast excellent damping capabilities. Due to their flexibility, Siegling Extremultus flat belts in the polyurethane line have good tracking characteristics and are particularly well suited for machinery with short center distances, manual take-up units and small drum diameters.

In addition, the polyurethane flat belts are 100% fray free and very easy to clean. That makes them perfect for use in areas where hygiene is vital.

## 2.3 ELECTROSTATIC PROPERTIES



It is essentially impossible to avoid static electricity when using power transmission and conveyor belts. It is created through the contact and subsequent separation of different materials (triboelectric effect), and can also be imported into the system by the conveyed product.

The consequences of electrostatic charging and uncontrolled discharges may be:

- Disruptions in production while processing foils and paper when the goods to be processed adhere to each other or to the belt
- Contamination through dust, lint, etc.
- Electric shocks
- Damage to electronic components (conveyed product and machine components)
- Fires and explosions

The goal for every power transmission and conveyor system must thus be to discharge the electrostatic charge in a controlled manner.

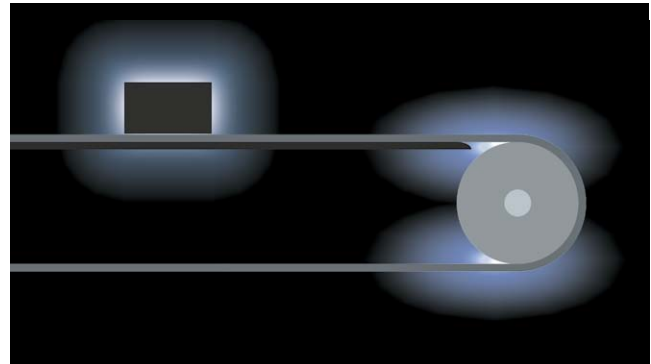

Static electricity through the conveyed product and the triboelectric effect.

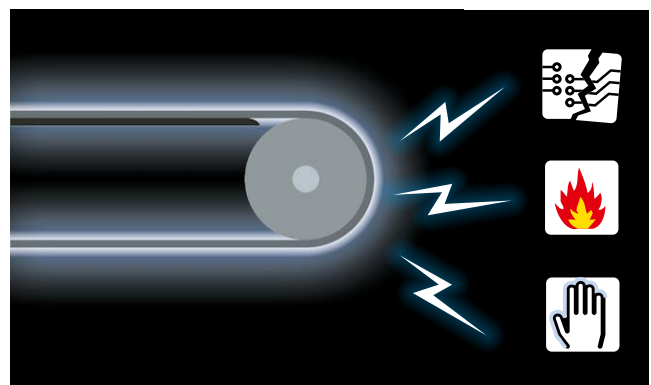

Hazards due to uncontrolled discharge of static electricity.

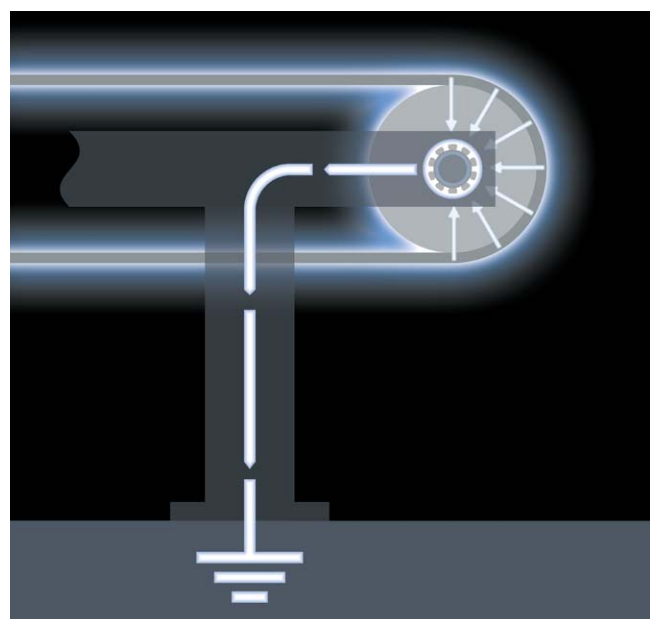

Controlled discharge of static electricity by selecting the correct flat belt

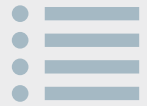

An antistatic feature is standard for Siegling Extremultus flat belts. Siegling Extremultus flat belts with special electrostatic properties are required for some applications. Products with the "NA" symbol are used in situations in which conductive components could disrupt the application, e.g. in metal detectors. All antistatic products contain elements that guarantee longitudinal conductivity. Products with a highly conductive surface are marked as "HC". The "HC+" symbol denotes all Siegling Extremultus flat belts that, in addition to their highly conductive surfaces, are also highly conductive in all three directions. These products are also assigned to the Flash Star™ product line, in other words the ESD-compliant flat belts.

[www.forbo.com/movement](http://www.forbo.com/movement) > [Products](#) > [Flat Belts](#) > [Flash Star](#)

Under certain conditions, Siegling Extremultus flat belts may be used in hazardous areas classified according to ATEX. Upon technical clarification and ultimate judgement by application support, Forbo Movement Systems can provide appropriate ATEX manufacturer declarations for individual products.

Observe European and relevant national regulations on explosion protection: 94/4 EC 2014/34/EU (ATEX), ISO 80079-36 and 37, BGR 132 of the Accident Prevention and Insurance Association for the German Chemicals Industry "Guidelines for the avoidance of ignition risks following electrostatic discharge".

#### **Non-antistatic (NA)**

Belt material with isolating properties.

#### **Antistatic (no special abbreviation)**

Belt material with electrically conductive components within the belt or on the surface.

Conductivity of the whole belt lengthways  $R_{DI} < 3 \cdot 10^8 \Omega$ .

#### **Highly conductive (HC)**

Conductive top face, usually conductive underside too. Must be antistatic as well.

Conductive on the surface lengthway  $R_{OB} < 3 \cdot 10^8 \Omega$ .

#### **Highly conductive plus (HC+)**

Conductive top face, underside and through the belt too.

Has to be highly conductive on both sides.

Conductive right through the belt  $R_D < 10^9 \Omega$ .

**Flash Star™**

## 2.4 FOOD PROPERTIES

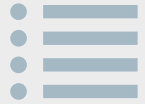

Observe the various regional laws/regulations when using Siegling Extremultus flat belts in the food industry. The flat belts bearing the FDA and HACCP acronyms are particularly well suited for contact with unpacked food:

Siegling Extremultus flat belts bearing the FDA symbol are suitable for the transport of unpacked food as per FDA 21 CFR. Beyond that, these products also generally meet the requirements of European Ordinance (EU) 10/2011 and (EC) 1935/2004. Please always observe the information on the relevant data sheet.

We will support your HACCP concept reliably and in compliance with legal requirements in all areas where hygiene is vital. Siegling Extremultus products with the HACCP designation boast a range of special product properties and subtypes. These components close any potential safety gaps in the manufacturing process.

Due to their excellent release properties, HACCP products are extremely advantageous when it comes to processing food with adhesive properties. Forbo Siegling offers belts with a unique surface finish to transport goods with a particular tendency to stick. They boast excellent release properties when it comes to particularly sticky products such as dough, caramel and other candy and they are easy to clean.

Contact your local representative for more information about products suitable for food:

[www.forbo.com/movement](http://www.forbo.com/movement) > [Contact](#)

You can find the certificates for the declarations of conformity on our website:

[www.forbo.com/movement](http://www.forbo.com/movement) > [Download](#) > [Declarations of Compliance](#)



# 2.5 NOMENCLATURE AND DATASHEET



## Nomenclature

Siegling Extremultus flat belts are named based on a helpful, transparent nomenclature. Both the structure and the important properties of the belt can be identified directly from the nomenclature. The following table features some typical examples.

| Article No. | Coating underside | Coating top face | Type number | Tension member material | Total thickness [1/10 mm] | Electrostatic property | Surface pattern overall or underside | Surface pattern top face | Color overall or underside | Color top face | Food properties |
|-------------|-------------------|------------------|-------------|-------------------------|---------------------------|------------------------|--------------------------------------|--------------------------|----------------------------|----------------|-----------------|
| 822130      | G                 | G                | 25          | A                       | – 25                      |                        | NSTR /                               | FSTR                     | grey /                     | black          |                 |
| 822154      | R                 | R                | 4           | E                       | –                         | HC+                    | NSTR /                               | NSTR                     | grey                       |                |                 |
| 822159      | T                 | T                | 15          | E                       | – 14                      | HC                     | FBRC                                 |                          | black                      |                |                 |
| 855635      | N                 | N                | 4           | P                       | –                         | HC+                    |                                      |                          | grey                       |                |                 |
| 850325      | G                 | G                | 14          | P                       | – 40                      |                        |                                      |                          | green                      |                |                 |
| 855646      | U                 | U                | 20          | U                       | – 9                       |                        | GSTR /                               | FSTR                     | black /                    | blue           | HACCP FDA       |
| 855647      | U                 | R                | 40          | U                       | – 12                      |                        | FSTR                                 |                          | blue                       |                | FDA             |

**Note:** Not all of the information is always found in the nomenclature of individual products, as the nomenclature has grown over time. The exact and complete information for each product can thus be found in the current data sheet.

## Data sheet

The data sheet contains all of the important information about the Siegling Extremultus flat belts in a clear, easily understandable way.

The information on the data sheets for the Siegling Extremultus flat belts is divided into the following groups:

- Available delivery width
- Design
- Technical data
- Properties
- Food properties
- Electrostatic properties
- Fabrication
- Minimum pulley diameter
- Applications
- Comments

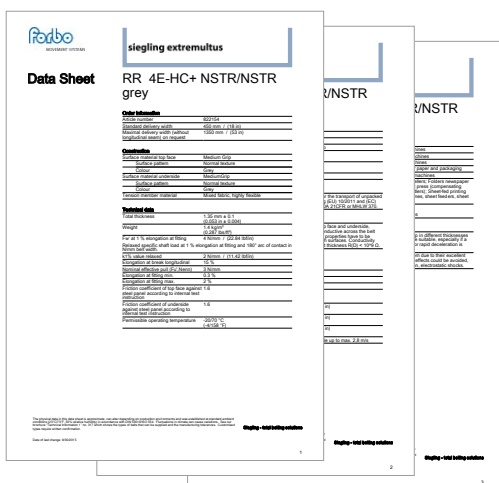

**Note:** You can find the data sheets for all of the Siegling Extremultus flat belts in the Product Finder (see Chapter 4.4). When searching for a flat belt, select “Details” and “Show data sheet” to open the respective data sheet. You can find the Product Finder for the Siegling Extremultus flat belts at:

[www.forbo.com/movement](http://www.forbo.com/movement) > E-Tools

## 2.6 GENERAL PROPERTIES OF FORCE-FIT BELT DRIVES

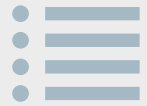

Force-fit belt drives belong to the group of traction drives. Due to the pretension or shaft load  $F_W$  and the friction  $\mu$  between belts and pulleys, it is possible to transfer an effective pull  $F_U$  from the driving pulley (1) to the driven pulley (2) with the help of the traction drive – the belt. Traction forces  $F_1$  and  $F_2$ , which must be absorbed by the belt construction, are created in flexible, elastic belts.

A variety of belt types are used in force-fit belt drives:

- Flat belt
- V-belt
- V-ribbed belts or
- round belts.

Regardless of the exact design and the traction belt used, force-fit belt drives have a number of things in common:

- technically uncomplicated, compact and cost-effective design
- large centerdistances, limited axles and multi-pulley drives possible
- traction drive generally easy to install and can be replaced
- virtually maintenance-free
- good damping properties and thus good vibration insulation
- lower noise level than mechanical gears
- no chordal action when transmitting power (compared to chains)

A certain phenomenon occurs in all force-fit belt drives: the rotations per minute – and the circumferential speed – on the driven pulley is slightly slower than the theoretically calculated value. This load-dependent loss is referred to as slip. A slip of up to 0.9% is referred to as creep. Creep occurs during normal belt operation and describes how the elasticity of the tension member compensates for the different forces and tensions in the two belt strands. Slip values above 0.9% are known as slippage. This is when the belt slips over the pulley. Both the transmission of power and the service life of the belt suffer when this occurs. Therefore, avoid operating the force-fit belt drive in the slippage area at all costs.

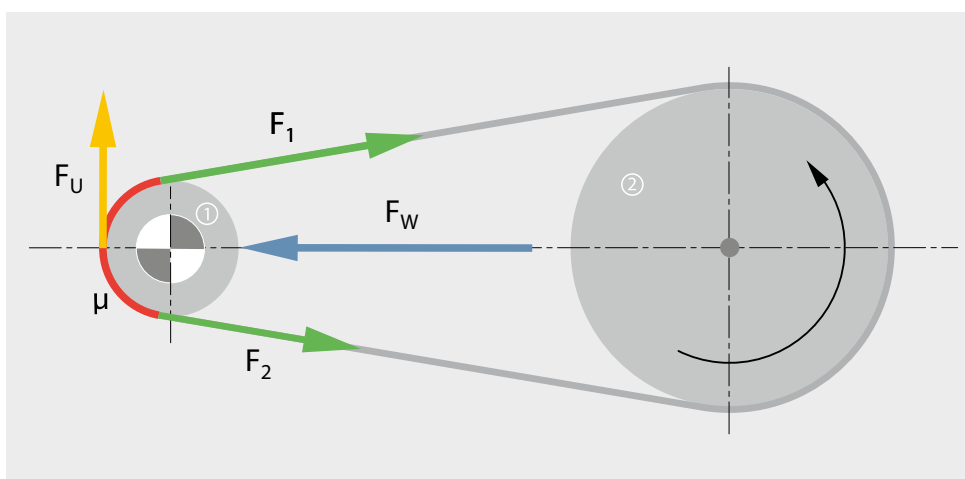

Representation of the transmission of power in a force-fit belt drive.



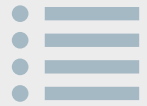

Slippage does, however, offer one great advantage over form-fit drives. In the event of unpredicted peaks in power, the belts simply slide off the force-fit belt drives, preventing more serious damage to the machinery and retaining their ability to function afterwards. Form-fit drives such as timing belt drives and gear drives require an expensive coupling to do this, e.g. a slip coupling to withstand peaks in power without damage.

Further losses, in addition to the slip, are generated during operation, depending on the shape and structure of the traction drive as well as the geometry of the pulleys. These losses include hysteresis and edge friction.

Edge friction only occurs between profiled belts such as the V-belt and the V-ribbed belt and their correspondingly shaped pulleys. Losses occur when the wedge or wedges are pulled into the pulley grooves and must be pulled out when running out of the grooves.

Hysteresis can be observed with all pulleys and describes the conversion of a small part of the kinetic energy into internal energy or heat inside the traction drive.

Furthermore, a force-fit belt drive is a system capable of vibration, similar to a taught guitar string. When designing the drive it is therefore important to consider the external influences that could potentially stimulate vibration in the system. [Chapters 9 and 10](#) explain in detail how to carefully design a flat belt drive.

In addition to these similarities, there are also significant differences between the different force-fit belt drives, primarily due to different traction drive constructions. A table in [Chapter 2.7](#) lists and compares the main features of force-fit belt drives for flat belts, V-belts and V-ribbed belts.

# 2.7 FORCE-FIT BELT DRIVES IN COMPARISON



|  | Flat belt   | V-belt   | V-ripped belt   |
|--|---|--|---|
|  |    |    |    |
| Rotations per minute max. [min <sup>-1</sup> ] | 130,000   | 10,000   | 12,500  |
| Circumferential speed max. [m/s]               | 200   | 50   | 60  |
| Bending frequency max. [Hz]                    | >250  | 100  | 200   |
| Temperature range [C°]                         | -50/+100  | -35/+80  | -35/+80   |
| Power limit [kW]                               | 5,000*  | 3,000  | 1,000   |
| Efficiency [%]                                 | >98   | 96   | 96  |
| Friction losses                                |   |  |   |
| – due to slip                                  | low   | low  | low   |
| – due to edge friction                         | none  | relatively high  | relatively high   |
|  |  |  |  |
| – due to hysteresis                            | low   | relatively high  | low   |
| Transmission                                   | up to 1:12  | up to 1:12   | up to 1:35  |
| Transmission ratio                             | variable<br>(cone belt drive)   | variable<br>(variable speed pulleys)   | constant  |
| Endless splicing<br>in the machinery           | common practice   | possible (15% less power<br>transmission)  | not possible  |
| Pulley geometry                                | simple  | complex  | complex   |

\* Generally possible, power limit depends on materials used. Observe information for respective flat belts. Please direct any questions to a Forbo Movement Systems contact person.

Round belts are not used for power transmission and are thus not included in this comparison.

Sources:

– VDI 2758: Riemengetriebe (June 1993)

– Peeken, Troeder, Fischer: Wirkungsgradverhalten von Riemengetrieben im Vergleich, Antriebstechnik 28 (1989) Nr. 1, pp. 42–45

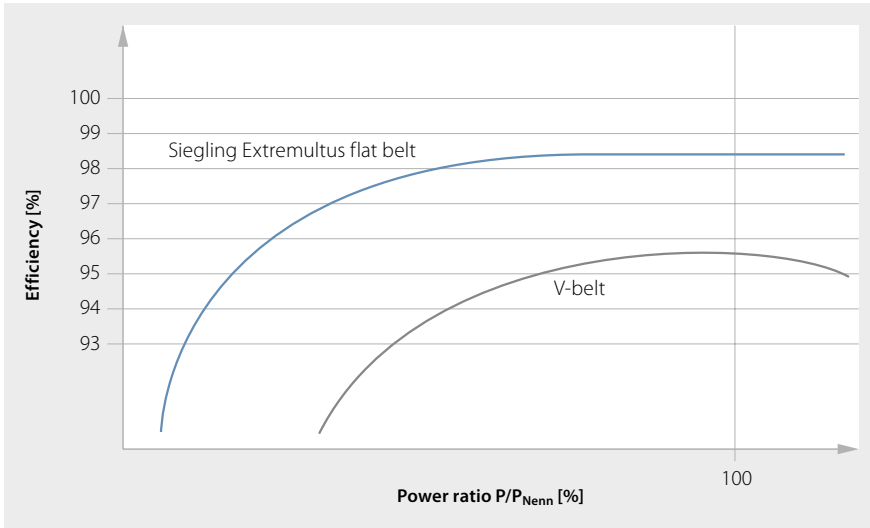

Efficiency of a flat belt.  
Siegling Extremultus flat belts have an efficiency of 98.6%.

Source:  
German Federal Institute for Materials Testing:  
„Untersuchungen an Riemengetrieben –  
Bericht zur Hannover Messe“ (1984)

### A set of V-belts

Slight variations in individual belt lengths result in:

- excessive slip
- different effective radii
- different tensions
- possibly jerky elongation compensation
- asymmetrical rotation
- increased edge friction

Higher friction losses when the V-belt pulleys are misaligned.

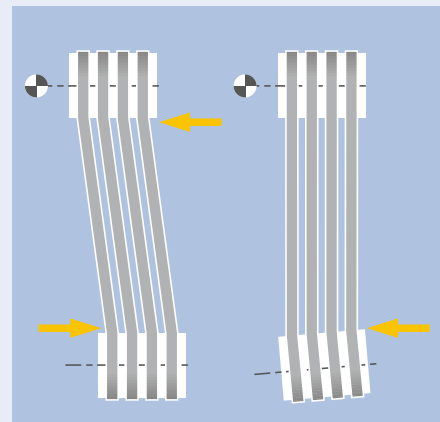
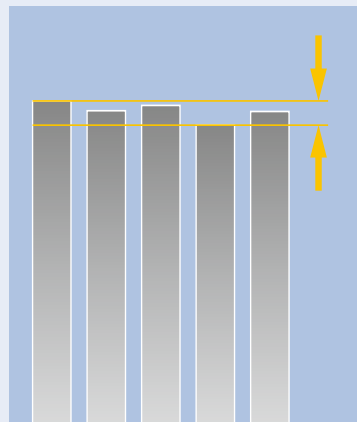

# 2.8 SPECIAL STRENGTHS OF FLAT BELTS

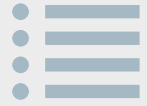

Flat belt drives can be used at high speeds, can transmit high power and are extremely efficient. In addition to the key technical information illustrated in [Chapter 2.7](#), they boast other interesting advantages.

## Versatile and simple drive design

Due to their great flexibility and the option of using both sides of the belt for drive tasks, flat belts can be used in a wide variety of drive configurations (see series of figures on next page).

As flat belts are custom made, there is no need to adhere to standardized lengths and widths when designing the drive. Due to their flat design, flat belts enable relatively low drum diameters. The even surface also makes the drive and drum pulleys easy to manufacture and thus cost-effective.

## Long lifetimes

Flat belts boast long lifetimes due to their high abrasion resistance. The constant friction coefficient guarantees constant RPMs across the entire service life. The materials used for tension members (polyester, aramide and polyamide) maintain their tension extremely well, necessitating re-tensioning in exceptional cases only. Flat belts with plastic tension members and elastomer coatings are maintenance-free.

Chrome leather coatings, used mainly for heavy duty drives, must be treated from time to time with a special spray paste in order to maintain smooth tracking and slip behavior ([see Chapter 6.4](#)).

## High efficiency

Flat belts are significantly more efficient than V-belts and V-ribbed belts. This is mainly due to friction losses. In addition to losses resulting from slip and hysteresis, which are minimal with flat belts and at times considerably higher with V-belts and V-ribbed belts, the edge friction present with V-belts and V-ribbed belts can also lead to friction losses. The more pronounced the wedge, the higher the contact surface between the edges of the wedge and the pulley. As the contact surface increases, so too does the edge friction and the friction losses.

When it comes to flat belts, the loss of efficiency as a result of slip is so minimal that the efficiency (> 98%) is in the range of form-fit drives such as timing belt drives and gear drives and sometimes even greater.

## Low operating noises

Flat belts produce high-frequency, low-amplitude noise. The coating on the underside of the belt can minimize noise, e.g. select a chrome leather layer or texture the elastomer layer. That is why flat belts generate considerably less operating noise than V-belts or V-ribbed belts.

## Wide range of application

Practically speaking, considering flat belts as pure drive elements often falls short. In addition to the classical drive function, they also provide great support when it comes to industrial (production) processes; e.g. processing boxes.

Flat belts have also been performing conveyor tasks for years. This has been primarily in the field of electronics and the food industry, including the manufacture of solar cells and the production of baked goods. These processes are far too complex for other types of belts.

- Flat belts are the only ones that can execute the necessary, sometimes highly complex, belt processes.
- Only flat belts have such a wide range of different characteristics at their disposal, including the fact that they can be food-safe and ESD compatible, etc.
- Only flat belts can be individually sized and fabricated, including the option of belt edge processing and the application of profiles etc.

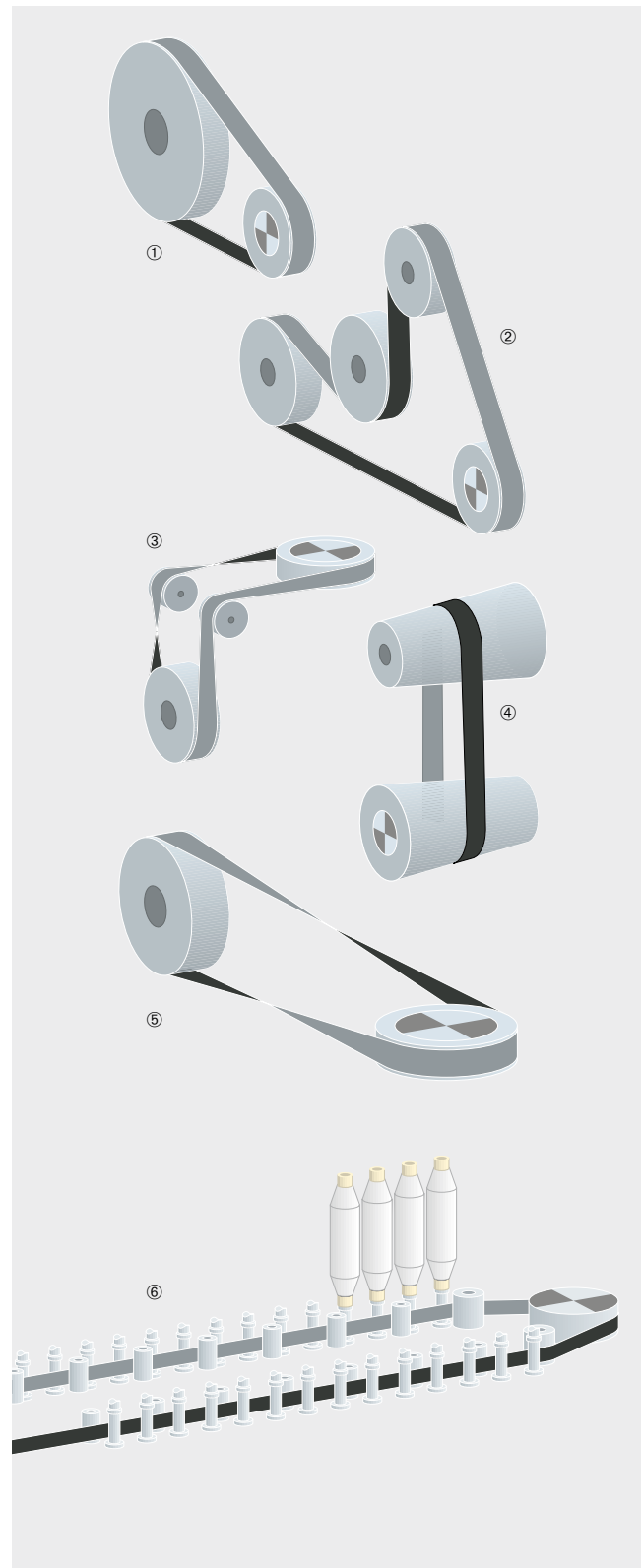

- ① Classical two-pulley drive
- ② Multiple pulley drive
- ③ Mule drive
- ④ Taper-cone drive
- ⑤ Half twist drive
- ⑥ Multi spindle drive

## 2.9 APPLICATION GROUPS

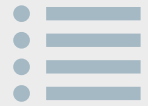

The material and structure of the tension member as well as the coatings of the top face and underside determine the characteristic profile of each flat belt. The Siegling Extremultus range offers a wide variety of products for the application groups, including different tension members and coating variants:

- Power Transmission Belts
- Live Roller Belts
- Tangential Belts
- Drag Belts
- Folder Gluer Belts
- Machine Tapes
- Elastic Food Tapes

The drive function is often mixed with sometimes extremely demanding process tasks, particularly in the last four groups. Siegling Extremultus flat belts boast versatile belt properties, perfectly supporting these processes.

### Siegling Extremultus Power Transmission Belts



**Siegling Extremultus Power Transmission Belts feature** impressively high efficiency ( $\geq 98\%$ ), outstanding synchronization accuracy and easy handling.

They are also characterized by:

- consistent and reliable speed and long service lives
- short take-up lines, low creep
- good damping capabilities
- durability up to a capacity of 1850 kW
- their ability to easily handle bevel and cone drives in which the belt rotates on its longitudinal axis

#### Typical coating combinations

- LT** = Leather underside, Fabric top face
- LL** = Leather underside and top face
- GT** = G elastomer underside, Fabric top face
- GG** = G elastomer underside and top face

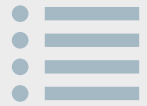

## Siegling Extremultus Live Roller Belts



Siegling Extremultus Live Roller Belts are energy-saving, durable drive components that ensure quick and reliable distribution.

They are also characterized by:

- durable friction layers with constant grip
- constant tension regardless of climate (aramide and polyester line)
- high flexibility and tensile strength
- low power loss due to reduced flexing force
- short downtimes due to quick installation

### Typical coating combinations

- GG** = G elastomer underside and top face
- UU** = Polyurethane underside and top face
- RR** = Medium Grip underside and top face

## Siegling Extremultus Tangential Belts

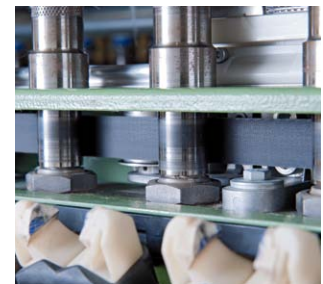

Siegling Extremultus Tangential Belts have been designed to suit the wide range of yarn-manufacturing processes and different drive shapes. They play a major role in ensuring consistently high yarn quality and efficient production thanks to the following characteristics:

- superior abrasion-resistant coatings made of elastomer G or polyurethane with constant friction coefficients and long service lives
- optimized surface textures for the spindle and motor side
- reduced belt slip and excellent levels of power transmission
- energy-efficient polyester or aramide tension members
- Highly orientated polyamide sheet tension members with good damping capabilities
- low-noise and low-vibration operation
- antistatic finishes

### Typical coating combinations

- GG** = G elastomer underside and top face
- UT** = Polyurethane underside, Fabric top face

## 2.9 APPLICATION GROUPS

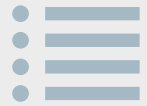

### Siegling Extremultus Drag Belts



**Siegling Extremultus Drag Belts** are special developments with superior mechanical and electrostatic characteristics which make conveying and handling electronic components more efficient and safe:

- thanks to the HC or HC+ properties (highly conductive or highly conductive plus) the static charge that builds up in the conveyor can be discharged in a more controlled manner
- due to simplified accumulation with TT types which produce consistently low friction coefficients on the top face and underside
- due to a particularly high level of abrasion resistance, as well as stable, fray free belt edges

#### Typical coating combinations

**TT** = Fabric underside and top face

### Siegling Extremultus Folder Gluer Belts

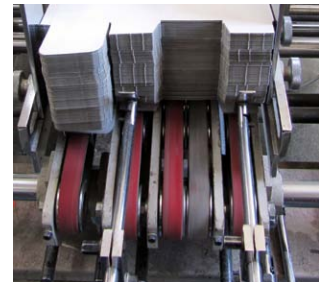
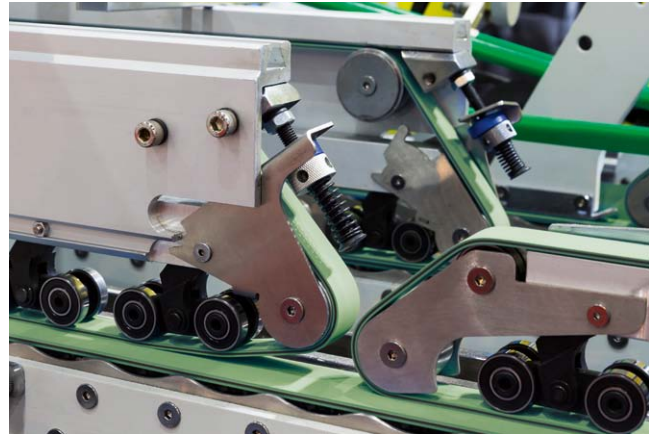

In the manufacture and processing of boxes and corrugated cardboard, **Siegling Extremultus Folder Gluer Belts** play a key role in ensuring that the quality and productivity potential of the machinery is exploited to the full. The Extremultus product range offers the right flat belt with specific characteristics for each application:

- thanks to tension-stable tension members made of polyester or aramide fabric, polyamide sheet or elastic polyurethane
- thanks to “custom grip” with a variety of surfaces that are gentle on products – also approved for direct contact with food
- thanks to constant grip and long service life

#### Typical coating combinations

**GG** = G elastomer underside and top face

**RR** = Medium Grip underside and top face



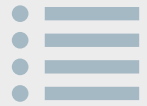

## Siegling Extremultus Machine Tapes

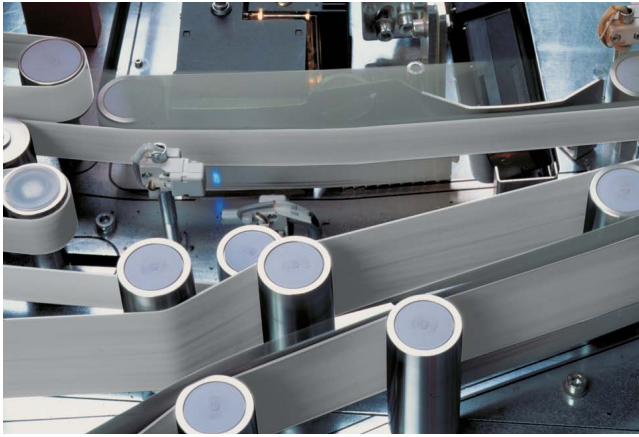

**Siegling Extremultus machine tapes** are vital components of machinery in many industrial applications. Tension members made of polyester fabric, polyamide sheet or polyurethane make them ideal for a range of different areas. Siegling Extremultus machine tapes boast:

- superior abrasion-resistant coatings with constant friction coefficients and long service lives
- surface textures and coatings, as well as electrostatic properties in keeping with requirements
- damping capability tailored to requirements (depending on the tension member)
- low elongation at fitting, low shaft load
- suitable for small drum diameters/rolling knife edges

### Different coating combinations, e.g.

- GG** = G elastomer underside and top face
- TT** = Fabric underside and top face
- TG** = Fabric underside and Elastomer G top face

## Siegling Extremultus Elastic Food Tapes

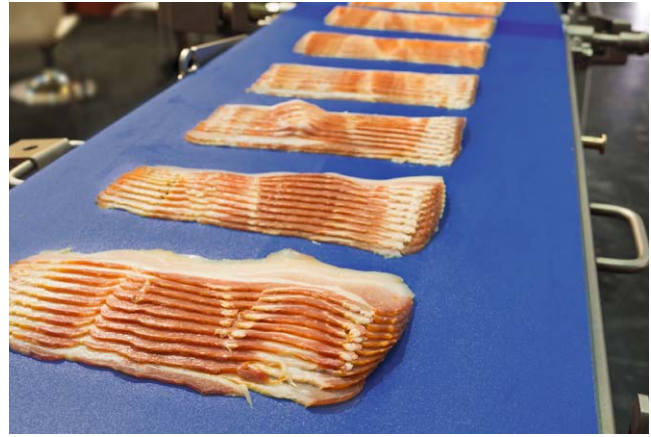

**Siegling Extremultus elastic food tapes** are specifically designed for applications in the food industry. The tension member is made of elastic polyurethane and is thus 100% fray free. Siegling Extremultus elastic food tapes are:

- food-safe; FDA and EU compliant
- available in blue or white to optimize quality assurance (contrast to food)
- elastic and thus excellent for short center distances, belt scales and are suitable as spreading belts
- easy to clean
- chemically resistant
- available with High Grip coating

Select Siegling Extremultus elastic food tapes also support the HACCP concept.

### Typical coating combinations

- UU** = Polyurethane underside and top face
- UR** = Polyurethane underside, High Grip top face





# 3 CHEMICAL RESISTANCE

3.1 [General information](#)

3.2 [Chemical resistance](#)

# 3.1 GENERAL INFORMATION



Information regarding the resistance of Siegling Extremultus coatings is based on laboratory testing and practical experience. It is valid in a standard climate (+23 °C/+73 °F and 50% relative humidity).

In the event of significant deviations from the standard climate, the resistance of the coatings may change. We recommend you check the resistances yourself to account for actual on-site conditions and the process media that affect the belt. We can supply appropriate samples upon request. Please contact us.

None of the Siegling Extremultus flat belts are resistant to organic or inorganic acids.

Siegling Extremultus flat belts featuring G, N, P, T, U, R coating materials are chemically impervious to oils and greases as well as most commercially available solvents. However, keep them free of grease and oil to ensure smooth functioning.

Siegling Extremultus flat belts with chrome leather (L) coating material are impervious to machine oil, diesel fuel, petrol, benzene, common solvents including ethyl acetate, acetone, etc. and chlorinated hydrocarbons such as perchloroethylene, etc.

Sub-types with leather coatings on one or both sides can be used where oil and grease are a factor.

**Note:** *The leather coating of Siegling Extremultus flat belts should be treated regularly with Siegling Extremultus Spraypaste, [see Chapter 6.4](#).*

The chemical resistance of Siegling Extremultus flat belts is of crucial significance, particularly in applications in which the belts are in direct contact with food. This mainly includes products featuring the coating materials U and High Grip R. In these applications it is also necessary to clean the flat belts frequently.

Belts with Medium Grip R and G coatings are used in folder gluer machines in the food industry.

The following tables list the chemical resistance of these coating materials compared to the most common substances from the three following areas:

- Pharmaceuticals, cosmetics
- Cleaning agents, general
- Food products

Detailed information about the chemical resistance of specific products is available on request. We would be happy to test our Siegling Extremultus flat belts to check their resistance to your cleaning agent on request. Please contact your local representative for more information:

[www.forbo.com/movement](http://www.forbo.com/movement) > [Contact](#)

## 3.2 CHEMICAL RESISTANCE



### Pharmaceuticals, cosmetics

|                         | Polyurethane U | High/Medium Grip R | G elastomer |
|-------------------------|----------------|--------------------|-------------|
| Aspirin                 | ●              | ●                  | ●           |
| Castor oil              | ●              | –                  | ○           |
| Hair shampoo*           | ●              | ●                  | ●           |
| Lanolin                 | ●              | –                  | ○           |
| Lysol                   | ●              | –                  | ○           |
| Mercury ointment        | ●              | ●                  | ●           |
| Nail polish*            | ●              | ○                  | ●           |
| Nail polish remover*    | –              | –                  | –           |
| Perfume                 | ●              | –                  | ●           |
| Pine needle oil         | ●              | –                  | ○           |
| Quinine                 | ●              | ●                  | ●           |
| Sagrotan (disinfectant) | ●              | –                  | –           |
| Soap (bars)             | ●              | ●                  | ●           |
| Soap (solution)         | ○              | ●                  | ○           |
| Spruce needle oil       | ●              | –                  | ○           |
| Sulphur ointment*       | ●              | –                  | ○           |
| Tincture of iodine      | ●              | ○                  | ○           |
| Toothpaste              | ●              | ●                  | ●           |
| Vaseline                | ●              | –                  | ●           |

### Cleaning agents, general

|                                      | Polyurethane U | High/Medium Grip R | G elastomer |
|--------------------------------------|----------------|--------------------|-------------|
| Acids, concentrated (strong)         | –              | ○                  | ●           |
| Acids, diluted (weak)                | –              | ●                  | ●           |
| Alcohols                             | ○              | ○                  | ○           |
| Aldehydes                            | –              | ●                  | –           |
| Aliphatic hydrocarbons               | ○              | ●                  | ●           |
| Amines                               | –              | ●                  | ●           |
| Aromatic hydrocarbons                | –              | –                  | –           |
| Chlorinated hydrocarbons             | ○              | ●                  | –           |
| Crude oil/mineral oil                | ●              | –                  | ●           |
| Ester                                | ●              | ●                  | –           |
| Ether                                | ●              | –                  | –           |
| Fats, oils                           | ●              | –                  | ●           |
| Fuels                                | ●              | ●                  | ○           |
| Halogens, dry                        | ○              | ○                  | –           |
| Hydrofluoric acid                    | –              | ●                  | ○           |
| Ketones                              | –              | –                  | –           |
| Lyes, concentrated (strong)          | –              | ●                  | ○           |
| Lyes, diluted (weak)                 | –              | ●                  | ●           |
| Organic acids                        | –              | ●                  | ○           |
| Oxidizing acids                      | –              | ●                  | ●           |
| Solutions of inorganic salts         | ●              | ●                  | ●           |
| Turpentine                           | –              | –                  | ●           |
| Unsaturated chlorinated hydrocarbons | –              | –                  | –           |
| Water, cold                          | ●              | ●                  | ●           |
| Water, warm                          | ●              | ●                  | ●           |

## 3.2 CHEMICAL RESISTANCE

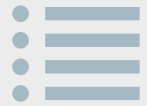

### Food products

|                                   | Polyurethane U | High/Medium Grip R | G elastomer |
|-----------------------------------|----------------|--------------------|-------------|
| Apple juice                       | ●              | ●                  | ●           |
| Apple sauce                       | ●              | ●                  | ●           |
| Beef tallow                       | ●              | –                  | ●           |
| Beer                              | ●              | ●                  | ●           |
| Blancmange                        | ●              | ●                  | ●           |
| Brandy                            | ●              | ●                  | ●           |
| Bread                             | ●              | ●                  | ●           |
| Butter                            | ●              | ●                  | ●           |
| Buttermilk                        | ●              | –                  | ●           |
| Cabbage, pickled                  | ●              | ●                  | ●           |
| Cake*                             | ●              | ●                  | ●           |
| Cheese                            | ●              | ●                  | ●           |
| Cinnamon, powder                  | ●              | ●                  | ●           |
| Cinnamon, sticks                  | ●              | ●                  | ●           |
| Citric acid                       | ●              | ●                  | ●           |
| Cloves                            | ●              | ●                  | ●           |
| Cocoa powder                      | ●              | ●                  | ●           |
| Cocoa, ready to drink             | ●              | ●                  | ●           |
| Coconut oil                       | ●              | –                  | ○           |
| Cod liver oil                     | ●              | –                  | ●           |
| Coffee (beans or ground)          | ●              | ●                  | ●           |
| Coffee (ready to drink)           | ●              | ●                  | ●           |
| Cola concentrates                 | ●              | ●                  | ●           |
| Cooking oil, animal               | ●              | –                  | ●           |
| Cooking oil, vegetable            | ●              | –                  | ●           |
| Corn oil                          | ●              | –                  | ●           |
| Corn (maize)                      | ●              | ●                  | ●           |
| Cream, whipped cream              | ●              | ○                  | ●           |
| Curd cheese                       | ●              | ○                  | ●           |
| Dairy products                    | ●              | ●                  | ●           |
| Dextrose                          | ●              | ●                  | ●           |
| Eggs (raw, boiled)                | ●              | ●                  | ●           |
| Fish                              | ●              | ●                  | ●           |
| Fish (pickled in various sauces)* | ○              | ●                  | ●           |
| Flour                             | ●              | ●                  | ●           |
| Fruit juices                      | ●              | ●                  | ●           |
| Fruit salad (fat-free)            | ●              | ●                  | ●           |
| Gelatine                          | ●              | ●                  | ●           |
| Gin                               | ●              | ●                  | ●           |
| Grain                             | ●              | ●                  | ●           |
| Grapefruit juice                  | ●              | ●                  | ●           |
| Grapes                            | ●              | ●                  | ●           |
| Gravy                             | ●              | ●                  | ●           |
| Honey                             | ●              | ●                  | ●           |
| Horseradish, ready to serve       | ●              | ●                  | ●           |
| Jam                               | ●              | ●                  | ●           |
| Jelly                             | ●              | ●                  | ●           |
| Lemon flavouring                  | ●              | ●                  | ●           |
| Lemon juice                       | ●              | ●                  | ●           |
| Lemon peel                        | ●              | ●                  | ●           |
| Linseed oil                       | ●              | –                  | ●           |

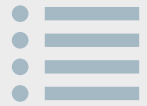

|                                   | Polyurethane U | High/Medium Grip R | G elastomer |
|-----------------------------------|----------------|--------------------|-------------|
| Liqueurs                          | ●              | ●                  | ●           |
| Margarine                         | ●              | –                  | ●           |
| Mayonnaise                        | ●              | –                  | ●           |
| Meat                              | ●              | ●                  | ●           |
| Milk                              | ●              | ●                  | ●           |
| Molasses                          | ●              | ●                  | ●           |
| Mustard                           | ●              | ○                  | ●           |
| Olive oil                         | ●              | –                  | ●           |
| Orange juice                      | ●              | ●                  | ●           |
| Palm oil                          | ●              | –                  | ●           |
| Paprika                           | ●              | ●                  | ●           |
| Peanut oil                        | ●              | –                  | ●           |
| Pepper                            | ●              | ●                  | ●           |
| Pineapple juice                   | ●              | ●                  | ●           |
| Pork dripping                     | ●              | –                  | ●           |
| Potato purée                      | ●              | ●                  | ●           |
| Potato salad                      | ●              | ●                  | ●           |
| Rice                              | ●              | ●                  | ●           |
| Rum*                              | ●              | ●                  | ●           |
| Salt herring                      | ●              | ●                  | ●           |
| Salt, dry                         | ●              | ●                  | ●           |
| Saltwater                         | ●              | ●                  | ●           |
| Sausage                           | ●              | ●                  | ●           |
| Semolina                          | ●              | ●                  | ●           |
| Soda water                        | ●              | ●                  | ●           |
| Soft drinks                       | ●              | ●                  | ●           |
| Soyabean oil                      | ●              | –                  | ●           |
| Starch solution, starch (aqueous) | ●              | ●                  | ●           |
| Starch syrup                      | ●              | ●                  | ●           |
| Sugar beet syrup                  | ●              | ●                  | ●           |
| Sugar, dry                        | ●              | ●                  | ●           |
| Sugar, solution                   | ●              | ●                  | ●           |
| Sunflower oil                     | ●              | –                  | ●           |
| Tartaric acid                     | ●              | ●                  | ●           |
| Tea, brewed                       | ●              | ●                  | ●           |
| Tea leaves                        | ●              | ●                  | ●           |
| Tomato juice                      | ●              | ●                  | ●           |
| Tomato ketchup                    | ●              | ●                  | ●           |
| Tomatoes                          | ●              | ●                  | ●           |
| Vanilla                           | ●              | ●                  | ●           |
| Vegetables, cooked                | ●              | ●                  | ●           |
| Vegetables, raw                   | ●              | ●                  | ●           |
| Vinegar 5 %                       | ○              | ●                  | ○           |
| Vinegar essence                   | –              | ●                  | –           |
| Water                             | ●              | ●                  | ●           |
| Whisky                            | ●              | ●                  | ●           |
| Wine, mulled wine                 | ●              | ●                  | ●           |
| Yeast                             | ●              | ●                  | ●           |

● = Good resistance | ○ = Limited resistance | – = No resistance | \* Belt's resistance depends on chemical composition

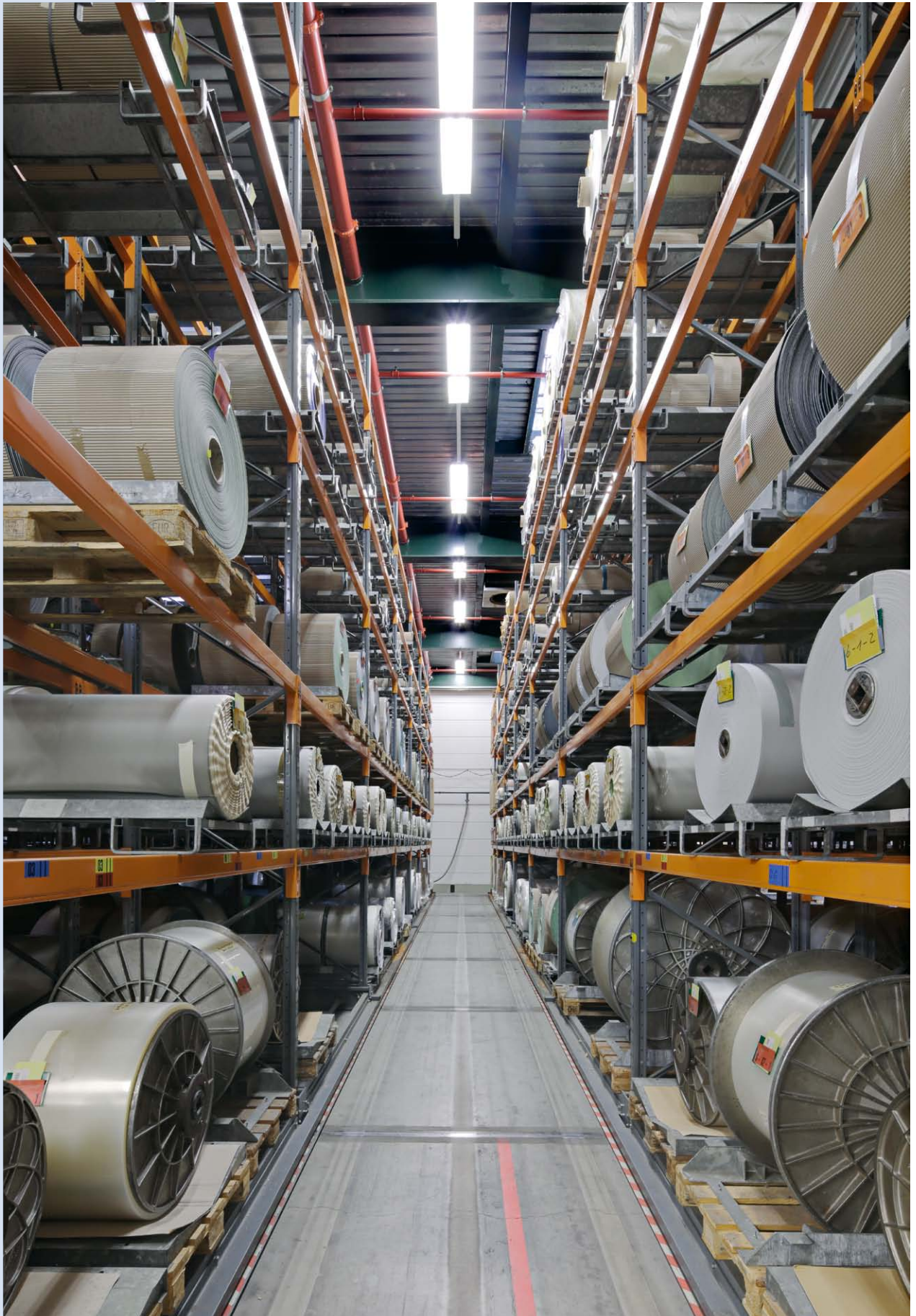





# 4 BELT SELECTION

- 4.1 [General information](#)
- 4.2 [Tension member](#)
- 4.3 [Coating materials](#)
- 4.4 [Extremultus Product Finder](#)
- 4.5 [B Rex Calculator](#)

# 4.1 GENERAL INFORMATION



Siegling Extremultus products are available in a variety of different material combinations.

The properties of the tension member and of the coating material are crucial when it comes to selecting the right, application-specific Siegling Extremultus product. The properties required depend on the overall context of use. To ensure proper belt selection, all of the parameters must be thoroughly determined.

The basic procedure when selecting a belt is usually as follows:

- Gather together all conditions of use
- Determine the tension member series and version
- Determine the coating materials
- Sizing

## Tension member properties

### **Max. elongation at fitting**

The maximum elongation at fitting is the maximum elongation with which a belt in this tension member series can be fitted in this application and still undergo no permanent damage due to excessive strand forces.

### **Initial value of the shaft load**

The initial value of the shaft load adjusts with a brand new, non-relaxed belt and is sometimes significantly higher than the calculated shaft load (in a steady state). The ratio between the initial value and the steady value of the shaft load is a function of the tension member material. More information on this topic is given in [Chapter 6.3](#).

Due to technical limitations in production as well as material and application-specific properties, not all material combinations are possible or sensible. Do not hesitate to get in touch with your local representative should you have any questions regarding the selection of Siegling Extremultus products for a specific application:

[www.forbo.com/movement](http://www.forbo.com/movement) > [Contact](#)

We will be delighted to help.

### **Effective pull transmission**

The effective pull transmission refers to the ability of the tension member series to transmit a high effective pull. The greater the (effective) pull transmitted per surface unit, the better the transmission capacity.

### **Climate resistance**

Climate resistance indicates whether and to what degree the respective tension member material is affected by climatic changes (temperature and humidity).

### **Damping**

Damping is a measurement of how well the belt and tension member can absorb and break down mechanical influences such as peaks in power and vibrations. Damping is thus directly proportional to the E-modulus of the material.

# 4.2 TENSION MEMBER

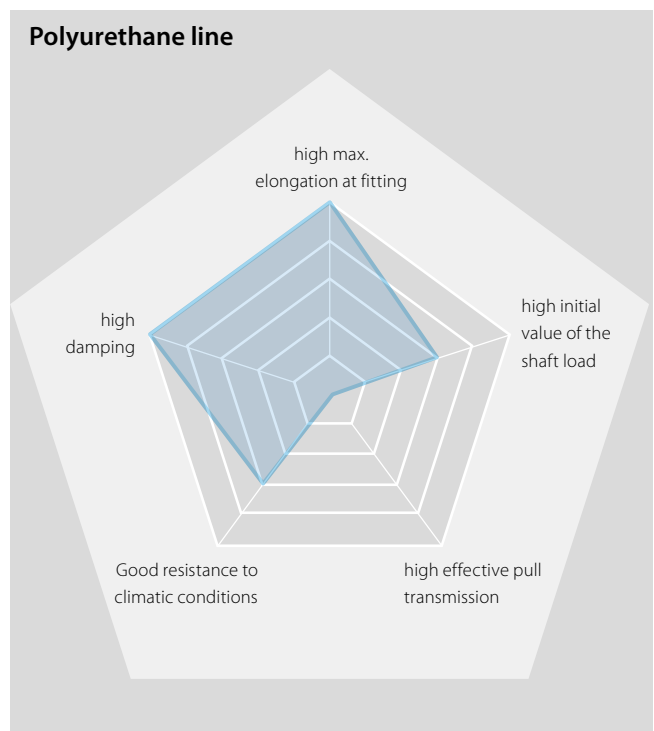
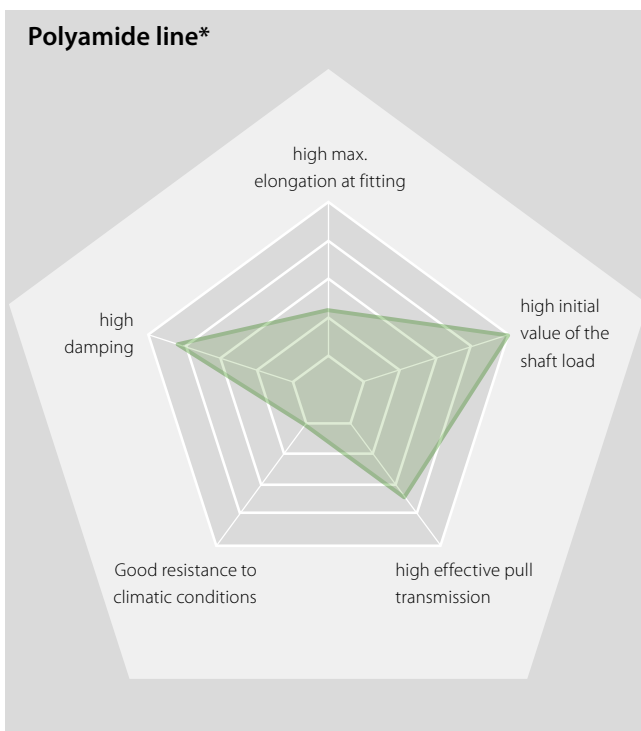
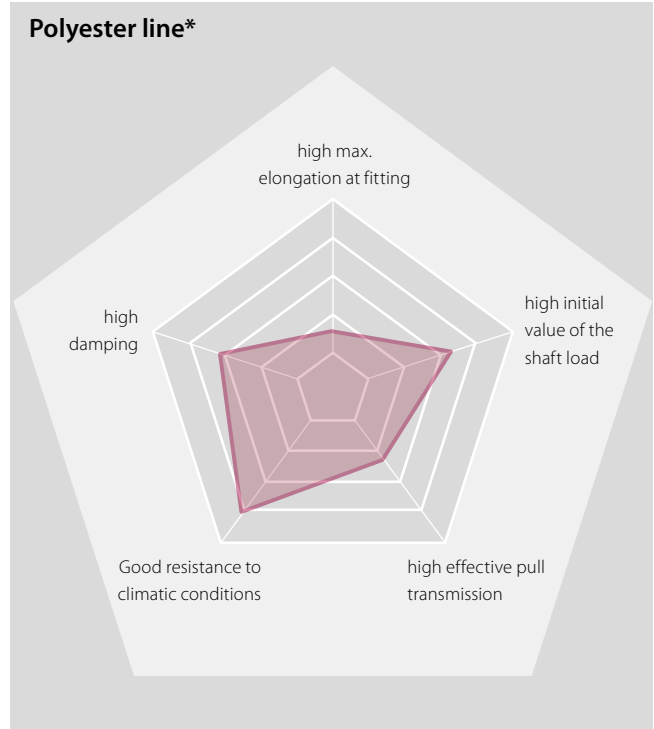
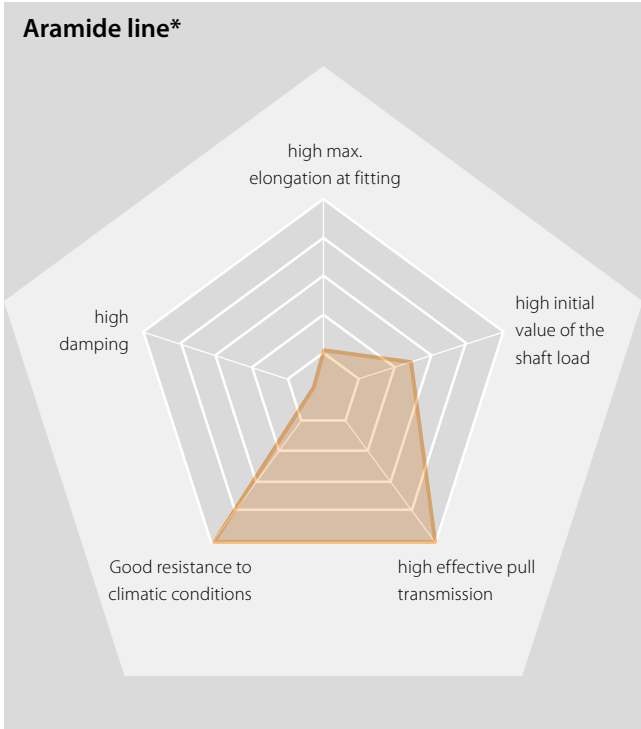
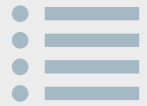

\* The material-specific properties shown apply to fabric tension members as well as sheets and endless cord.

# 4.3 COATING MATERIALS



## Coating material properties

### Abrasion resistance

Abrasion resistance refers to contact with the usual materials in the corresponding applications.

### Transport capacity

Transport capacity is derived from the friction coefficients between the coating materials and a steel plate. The friction coefficients are measured as part of Forbo Movement Systems' internal, standardized tests.

### Operating noise

The operating noise depends on the surface pattern and the hardness of the coating material. The conveyor design also plays a significant role here.

### Temperature stability

Temperature stability is the temperature range in which the materials or belts can be operated without the materials undergoing irreversible thermal disintegration as a result of high temperatures or damage as a result of brittleness at low temperatures.

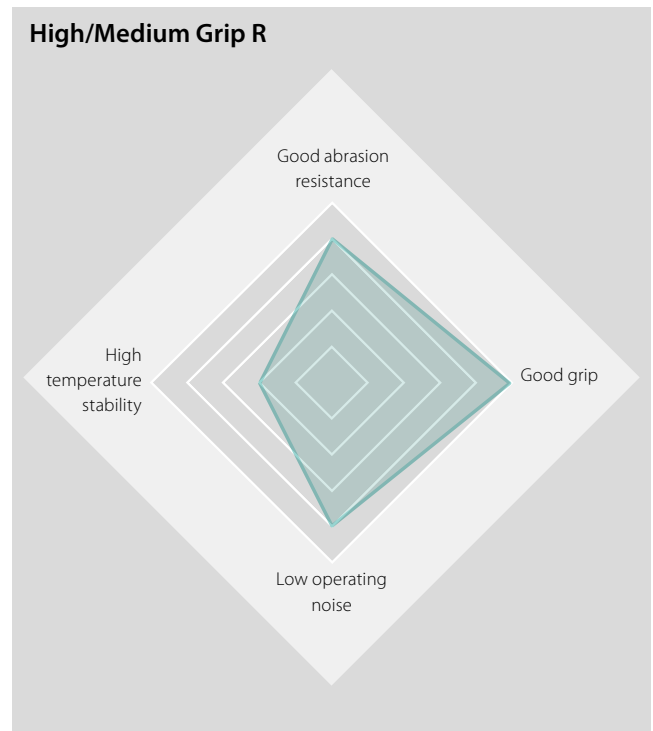
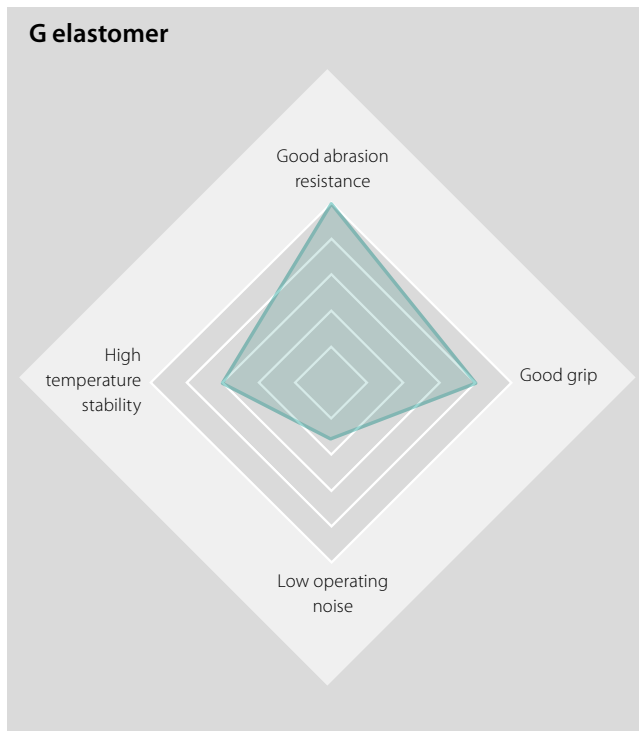

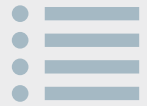

### Chrome leather L

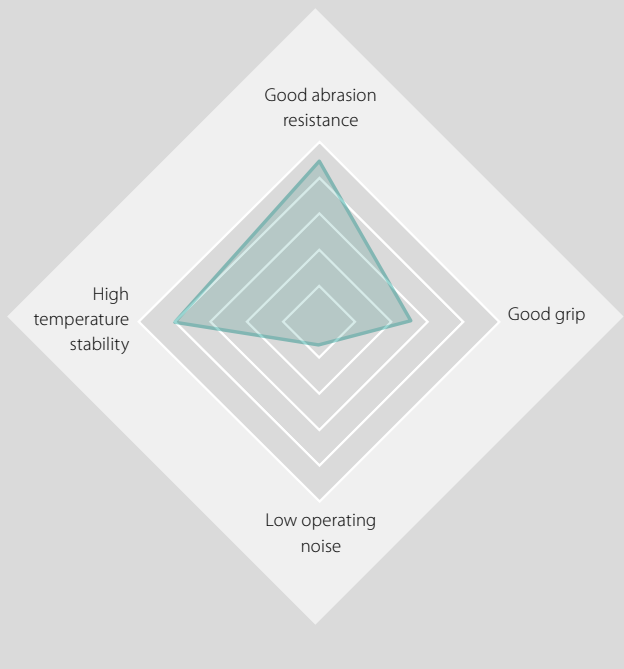

### Fabric T

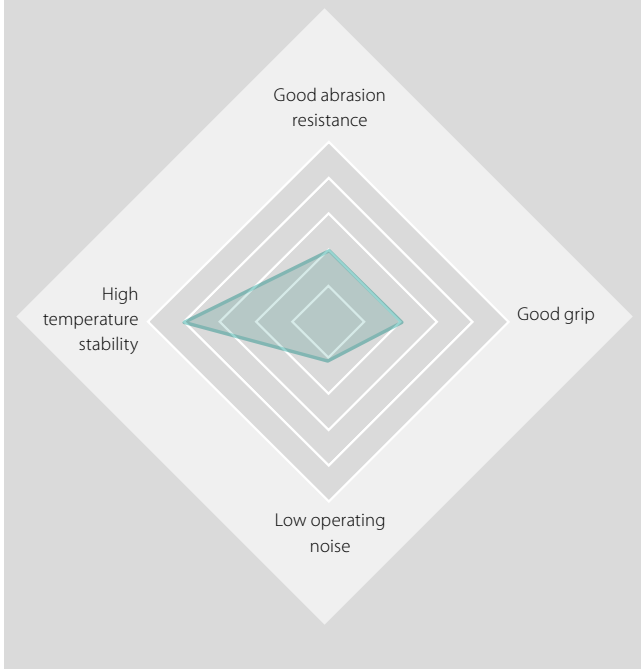

### Nonwoven polyester N

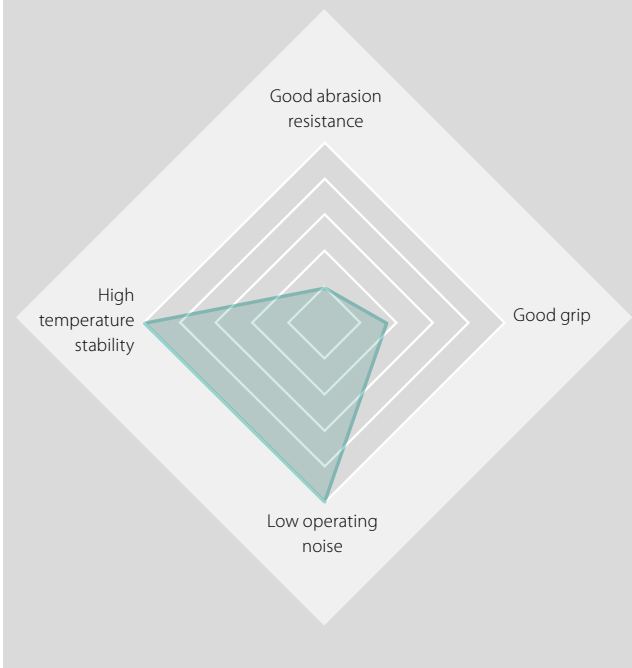

### Polyurethane U

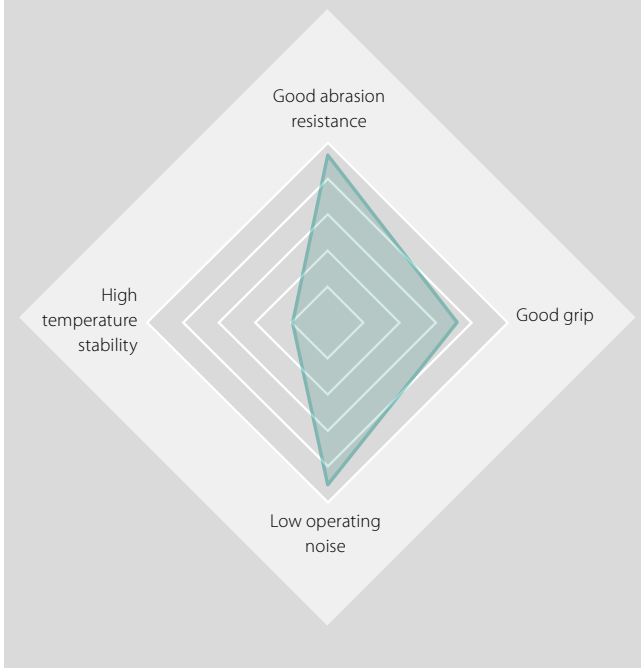

# 4.4 EXTREMULTUS PRODUCT FINDER

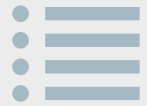

The Extremultus Product Finder provides a pragmatic option for selecting belts. This convenient finder is available as an e-tool on the Forbo Movement Systems homepage and is optimized for both computers and mobile devices. [www.forbo.com/movement](http://www.forbo.com/movement) > E-Tools

A successful search or filtering process displays a list of results. The article number, type designation and data sheets (see Chapter 2.5) in PDF format are then available for all of the products in the results list. Inquiry can be placed directly.

The Extremultus Product Finder is a search engine used to search for, filter and ultimately display all of the Siegling Extremultus products based on their technical data, significant parameters and specific properties. It is also possible to filter according to application group and text retrieval.

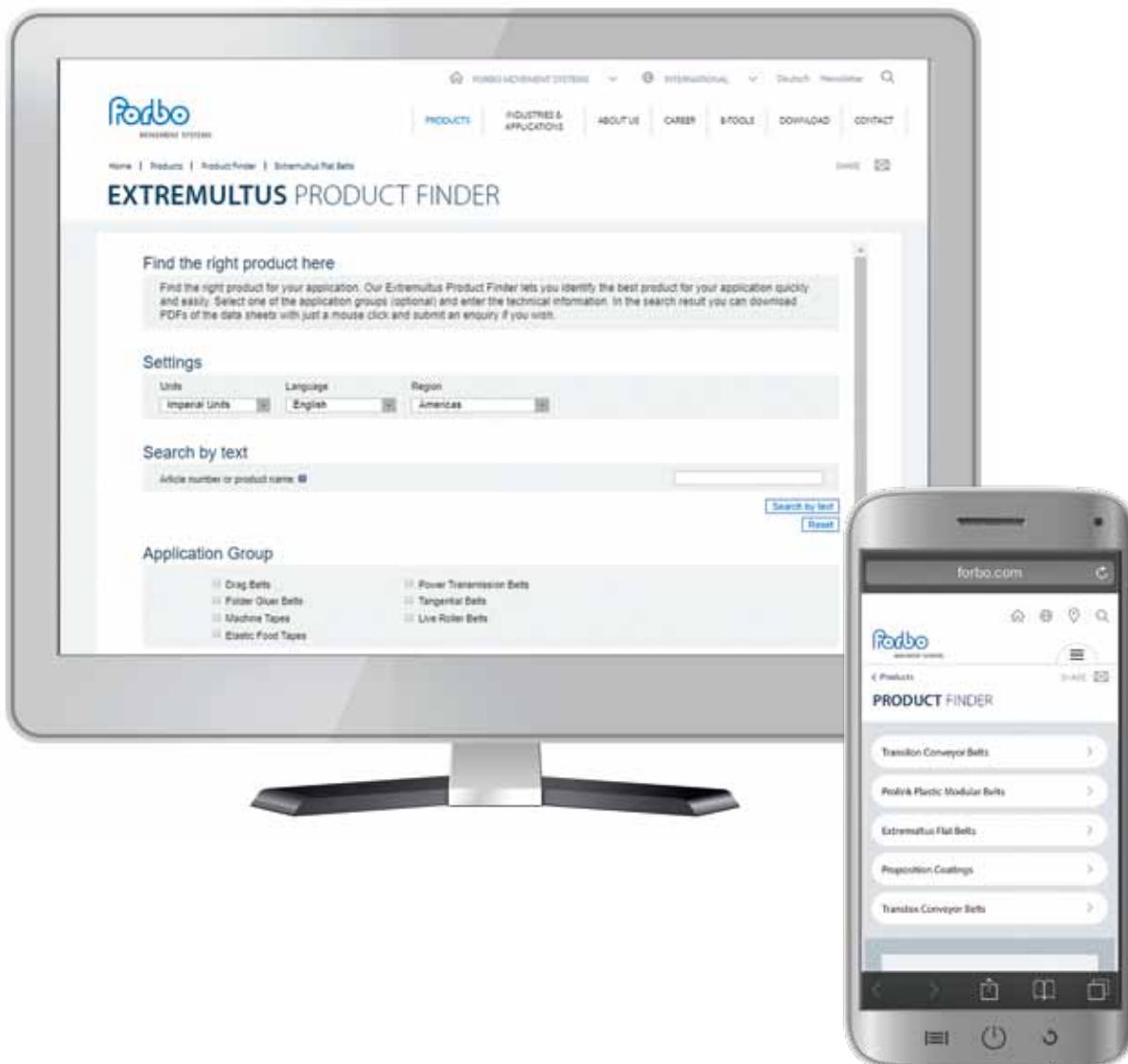

# 4.5 B\_REX CALCULATOR

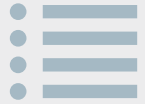

Forbo Movement Systems has been designing customer applications with its in-house calculator B\_Rex for years. You receive the calculator free of charge upon registration at: [www.forbo.com/movement](http://www.forbo.com/movement) > E-Tools

B\_Rex makes it possible to simulate the reproduction and changing of conveyors and drives on the PC, simulating the combination of any system with any Siegling Extremultus flat belt. The product data is included with the program in the form of a database.

As a general rule, designing with B\_Rex is divided into four easy steps. All the designer is required to do is input information that s/he already knows. Any parameter changes in the design result immediately in a new calculation, making the system very easy to optimize. B\_Rex is freely available and is currently the most advanced calculator with the most possibilities in the field of light materials handling. The program also contains instructions in PDF format.

The B\_Rex calculator is a convenient option for calculating and visualizing the development of belt force and elongation at fitting for any belt configuration. Typical elements in materials handling such as live rollers, skid plates etc. can be modeled quickly using configurable components.

For classic roller conveyors with rear or head drives, prefabricated models are available to support frequent system modelling. There is also a separate calculation model available for the classic 2-pulley power transmission drive. In addition, a vibration analysis is carried out for each belt segment. This analysis issues a warning prior to any transversal vibrations ("flapping") of the flat belt, something that can considerably shorten the lifetime of the belt.

Each version of the program has a time limit for our customers. This is to ensure that the current version is downloaded at regular intervals so that customers remain up-to-date at all times when it comes to bug fixes and our current product range.

We hope you enjoy working with this program. Please direct any questions or problems to: [brex@forbo.com](mailto:brex@forbo.com)

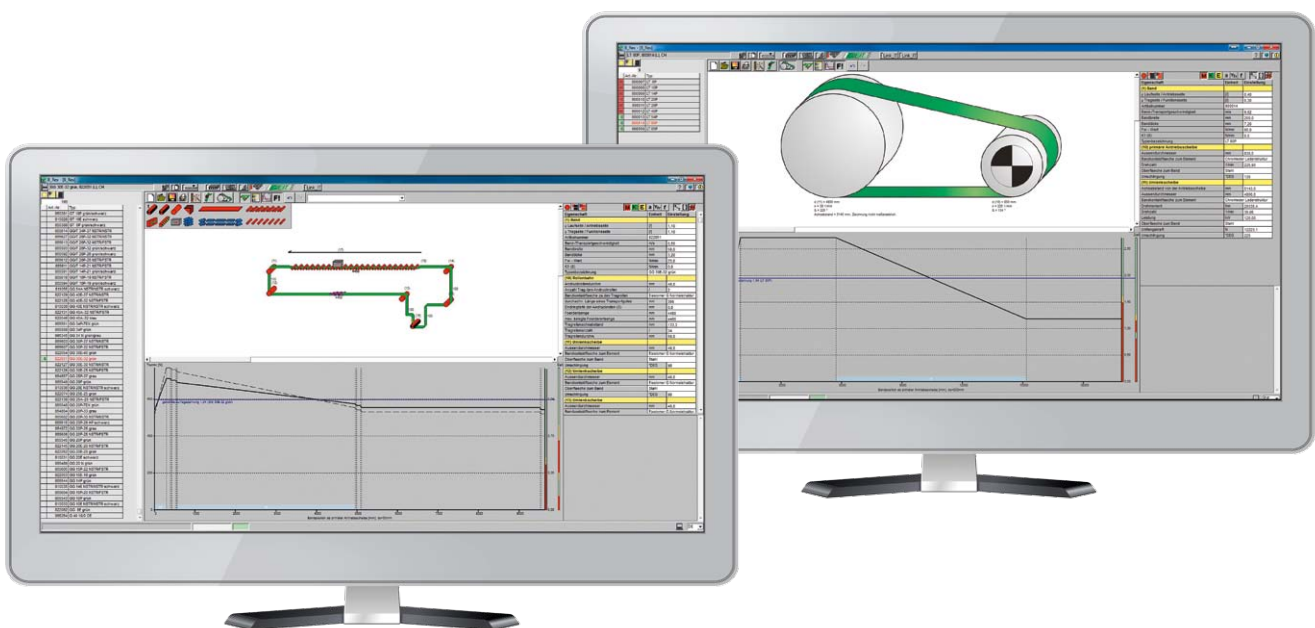







# 5 MANUFACTURING DATA

5.1 [Manufacturing tolerances](#)

5.2 [Delivery dimensions](#)

# 5.1 MANUFACTURING TOLERANCES



As a general rule the manufacturing tolerances indicated in the following tables apply. They do not include any geometric changes that may occur following manufacture as a result of climatic fluctuations or other external influences. In some cases, special tolerances are also possible upon request. Please contact your local representative: [www.forbo.com/movement](http://www.forbo.com/movement) > [Contact](#)

## Length tolerances

| Polyester line and Aramide line (fabric) |          |
|--|----------|
| 300 – 5000 mm                            | ± 0.30 % |
| 5001 – 15000 mm                          | ± 0.20 % |
| > 15000 mm                               | ± 0.15 % |
| Polyester line and Aramide line (cord)   |          |
| 500 – 1000 mm                            | ± 0.50 % |
| 1001 – 5000 mm                           | ± 0.40 % |
| > 5000 mm                                | ± 0.30 % |
| Polyamide line (sheet and fabric)        |          |
| 300 – 5000 mm                            | ± 0.50 % |
| 5001 – 15000 mm                          | ± 0.30 % |
| > 15000 mm                               | ± 0.20 % |
| Polyurethane line                        |          |
| 300 – 5000 mm                            | ± 0.30 % |
| 5001 – 15000 mm                          | ± 0.20 % |
| > 15000 mm                               | ± 0.15 % |

## Width tolerances

| Polyester line and Aramide line (fabric) |               |
|--|---------------|
| 10 – 120 mm                              | + 0.2/–0.3 mm |
| 121 – 500 mm                             | ± 1.5 mm      |
| > 500 mm                                 | ± 5.0 mm      |
| Polyester line and Aramide line (cord)   |               |
| 20 – 50 mm                               | ± 1.0 mm      |
| 51 – 100 mm                              | ± 1.5 mm      |
| 101 – 250 mm                             | ± 2.0 mm      |
| > 250 mm                                 | ± 3.0 mm      |
| Polyamide line (sheet and fabric)        |               |
| 10 – 50 mm                               | ± 1.0 mm      |
| 51 – 120 mm                              | ± 2.0 mm      |
| 121 – 500 mm                             | ± 3.0 mm      |
| 501 – 1000 mm                            | ± 10.0 mm     |
| Polyurethane line                        |               |
| 10 – 120 mm                              | + 0.2/–0.3 mm |
| 121 – 500 mm                             | ± 1.5 mm      |
| > 500 mm                                 | ± 5.0 mm      |

## Thickness tolerances

Siegling Extremultus flat belts can have different thickness tolerances depending on the combination of tension member and coating material. Please always observe the information on the respective data sheets.

## Tolerances for perforations

| All lines             |          |
|-----------------------|----------|
| Diameter of hole      | ± 0.5 mm |
| Spacing between holes | ± 1.0 mm |

# 5.2 DELIVERY DIMENSIONS

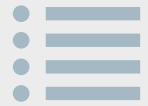

Siegling Extremultus products are produced in large widths and extremely long lengths of roll material. The products can then be delivered in different, customer-specific ways, depending on production or standard delivery dimensions.

## Available as

All Siegling Extremultus flat belts, except for those with tension members made of truly endless cord, can be delivered in the following three forms:

- Open, as roll material
- Prepared for on-site installation in the following variants
  - cut at 90° or 60° angles
  - prepared for being made endless on one side
  - prepared for being made endless on both sides
- Endless, spliced and ready to install (even flat belts with tension members made of endless cord)

Please contact your local representative for more information about the delivery forms available:

[www.forbo.com/movement](http://www.forbo.com/movement) >  
[Contact](#)

We will be delighted to help.

## How to measure order length

When ordering flat belts spliced endless, the length is measured inside, i.e. on the underside.

To do this, place the flat belt on its edge, affix a steel tape firmly on its inside (Fig. 1) or measure directly over the pulleys (Fig. 2).

If your machinery has a take-up unit, it should be adjusted to determine the order length as shown in figure 3.

The order length should be determined when the take-up unit is in the zero position. We recommend selecting a zero position for the take-up unit that enables a take-up line greater than the path required to apply the elongation at fitting. In addition, it should be possible to have a return distance from the zero position that is greater than the minus tolerance when manufacturing the belt.

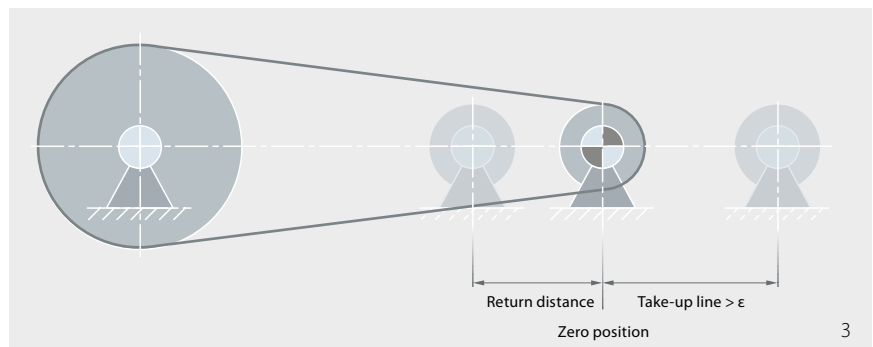
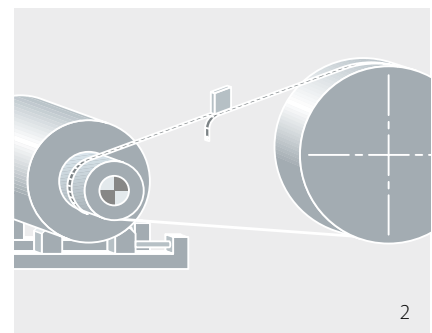
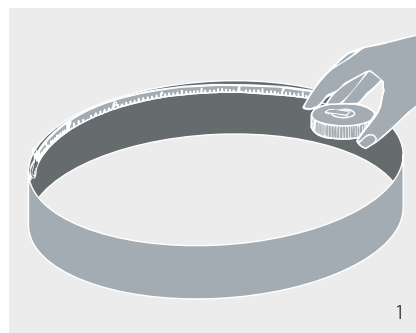





# 6 HANDLING FLAT BELTS

- 6.1 [Storage](#)
- 6.2 [Condition of machinery](#)
- 6.3 [Fitting and tensioning](#)
- 6.4 [Maintenance and handling](#)

# 6.1 STORAGE

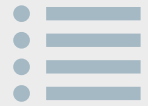

Due to the specific properties of the Siegling Extremultus flat belts, there are a few things to consider when it comes to storage conditions:

- The belts should be stored under normal ambient conditions climate (23 °C/+73 °F, 50% humidity) as per DIN EN ISO 291
- Do not lay the material on the belt edge. Instead, hang it up on a pipe or similar (Fig. 1) or, if there is no other option, store in an upright position (Fig. 2).
- Upon consultation, high-quality flat belts (e. g. tangential belts) with polyamide tension members are sent from our factory in special air-tight bags. Do not open the bags until the belts are ready to be fitted
- Do not expose flat belts to direct sunlight (take special care with G, R and U coatings)

The material – especially the polyamide line – can deform slightly if exposed to humidity or heat on one side. But this deformation will disappear once elongated by 0.2 to 0.4%, guaranteeing smooth running. Moisture greatly affects Siegling Extremultus flat belts with polyamide tension members. The E-modulus, and with it the important proper-

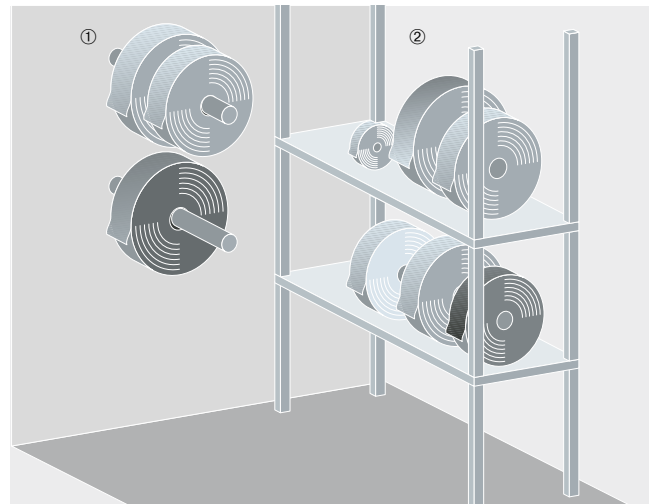

ties of the flat belt, can undergo significant change when used in a moist environment or on contact with water. If you are using flat belts with this tension member in extreme ambient conditions, we recommend you contact Forbo Movement Systems application support.



## 6.2 CONDITION OF MACHINERY



The condition of the machinery operating the flat belts is an important factor when it comes to maximizing the service life of the Siegling Extremultus flat belts. The maximum service life of the flat belts and their smooth operation can only be guaranteed if the machinery is in faultless condition. The following list contains points that, if not followed, will lead to the premature failure of the flat belt:

- Clean any anti-corrosion agents, dirt and oil from the pulley faces
- Check parallelism of shafts and align pulleys, adjusting in accordance with manufacturer's instructions as needed
- Check and ensure that all drum and support rolls are running smoothly
- Eliminate any possibility of the flat belt running up during operation. This includes using pulleys without flanges ([see also Chapter 8](#)) as well as checking the distances between the frame or housing of the machinery and the flat belts and adjusting if necessary.
- Ensure that the machinery and its surroundings are clean. Dirt/deposits on the underside of the flat belt can lead to excessive mechanical load and/or excessive slip, destroying the flat belt.

**Note:** Further information to improve the lifetime of Siegling Extremultus Flat belts as well as information to fix flaws and causes of failures, you will find in [Chapter 11](#).

# 6.3 FITTING AND TENSIONING

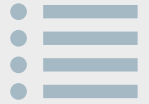

## Fitting

Improper handling when fitting the Siegling Extremultus flat belts poses the risk of damaging the belts to such an extent that the fatigue strength of the flat belts in operation can no longer be guaranteed. For this reason only qualified professionals should fit and tension the belts if at all possible. We would be delighted to set up an appointment to install the flat belts on-site.

[www.forbo.com/movement](http://www.forbo.com/movement) > [Contact](#)

Always observe the instructions specified by the machine manufacturer when fitting the Siegling Extremultus flat belts. Never wind Siegling Extremultus belts over pulley edges or use accessories which cause damage to the flat belt edges and result in bends or tears in the belt.

Flat belts in the aramide line are particularly susceptible to this type of damage (due to the aramide tension member).

Most machines have a clamping device to decrease the center distance between the pulleys in order to fit the flat belts. If this is not the case or if the take-up of the clamping device is not large enough, size the flat belt so that the required tension is reached upon fitting.

Possible tools include:

- mounting cone (a)
- chain hoist (b – use only with polyamide line)

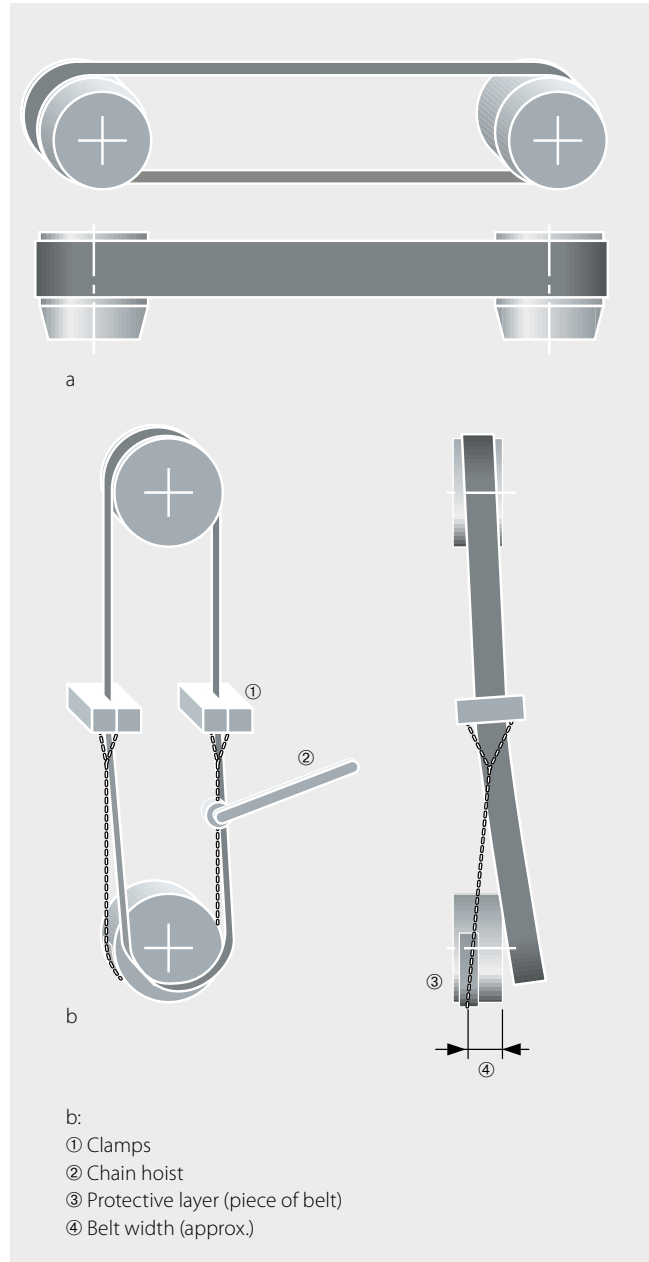



In addition to the methods used to fit the flat belts, the direction of the belt in relation to the wedge splice must also be taken into account for flat belts with polyamide tension members.

The cross-section view of the wedge splice shows that this splice type has a front edge which, depending on how the flat belt is aligned in relation to the direction, is either on the top face or the underside of the flat belt.

Circulation on the pulleys will be smooth and the splicing area will have non-critical contact with the conveyed goods when the front edge is on the opposite side of the critical contact point (pulley or conveyed goods).

The critical contact point depends on the use of the Siegling Extremultus flat belt.

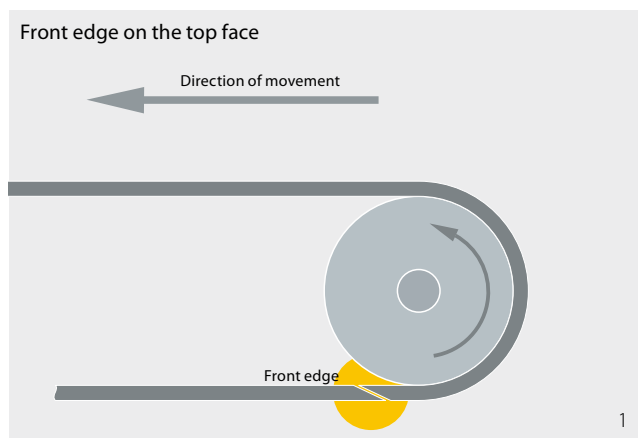

If, for example, the flat belt is used as a power transmission belt in a 2-pulley drive, contact with the pulley is seen as the critical contact point because the pulley is generally the only contact with the flat belt. To guarantee improved durability for the wedge splice, it is a good idea to align it as shown in Figure 1.

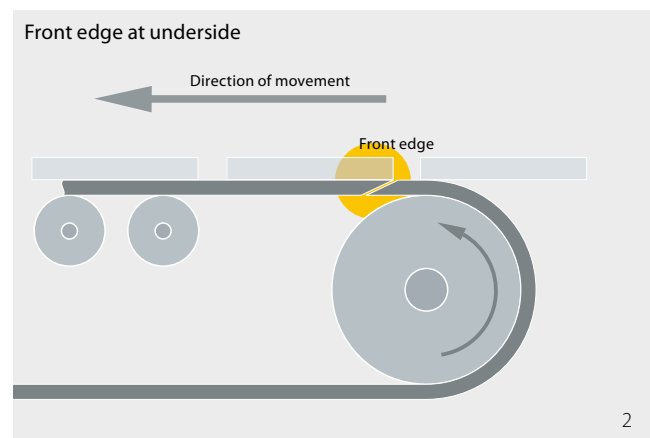

If, however, the flat belt is used to transport an abrasive product such as paper, the critical contact point is between the flat belt and the conveyed goods. Contact with the pulley then usually plays a minor role. We recommend alignment as shown in figure 2.

# 6.3 FITTING AND TENSIONING

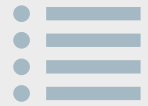

## Tensioning

Flat belts must be pre-tensioned in order to transmit a given torque without slippage. This tension is usually applied using the machine's tensioning device. Thereby, the flat belt will be stretched and this leads to an elongation compared to the non-tensioned initial state. This so called elongation of fitting is given in percent and results from detailed calculation and dimensioning of the Siegling Extremultus flat belt for a specific application.

The basic standard values for the elongation at fitting of the different tension members regarding different applications are specified in the shown table.

A variety of different methods and tools can be used to tension and elongate the Siegling Extremultus flat belts.

| Product line      | Tension design       | Application Group/ Function  | Recommended Elongation at fitting [%]     |
|-------------------|----------------------|--|---|
| Aramide line      | Fabric               | Power Transmission Belts<br>Tangential Belts<br>Live Roller Belts  | 0.3–1.0<br>0.3–0.8<br>0.2–0.5             |
|                   | Cord (truly endless) | Power Transmission Belts   | 0.3–1.0                                   |
| Polyester line    | Fabric               | Power Transmission Belts<br>Tangential Belts<br>Folder Gluer Belts*,<br>Drag Belts,<br>Maschine Tapes*<br>Live Roller Belts* | 1.0–2.0/2.5**<br>1.5–2.0/2.5**<br>0.3–2.0 |
|                   | Cord (truly endless) | Power Transmission Belts,<br>Maschine Tapes*   | 0.5–1.5                                   |
| Polyamide line    | Fabric               | Maschine Tapes*  | 0.6–3.0                                   |
|                   | Sheet                | Power Transmission Belts,<br>Live Roller Belts<br>Tangential Belts<br>Rotor Belts<br>Folder Gluer Belts*,<br>Drag Belts      | 1.5–3.0<br>1.8–2.8<br>2.5–3.5<br>1.5–3.0  |
| Polyurethane line | Foil                 | Maschine Tapes*  | 3.0–8.0                                   |

\* Tension just enough so they operate properly

\*\* Max. Elongation at fitting 2.5% possible for GG 40E-32 NSTR/NSTR grey/black (822128) and GG 40E-37 NSTR/NSTR black (822129)

### Measuring marks

With the belt placed flat, apply two thin measuring marks at a defined distance, e.g. 1000 mm, on the top face of the flat belt. After fitting, use the take-up unit to elongate the flat belt lengthways until the distance between the measuring marks reaches the calculated value (see sample calculation in the table below).

It makes sense to turn the drive several times after following the first elongation and then check the elongation value and correct if necessary. Only by turning can the elongation be distributed along the entire length of the belt.

**Note:** Do not measure above the splice area!

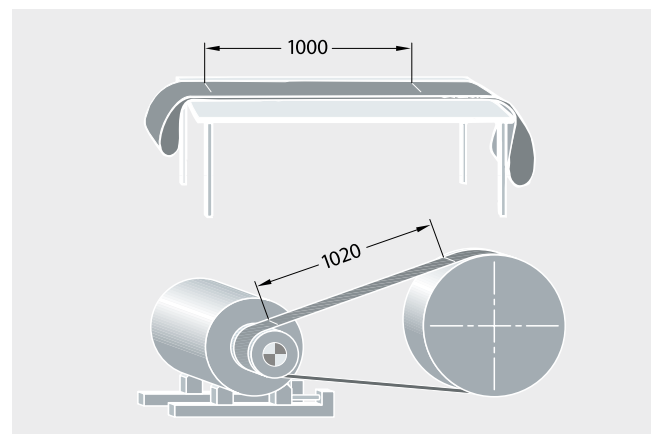

Example: Distance between measuring marks for a required 2% belt elongation.

| not elongated | elongated |
|---------------|-----------|
| 1000 mm       | 1020 mm   |
| 500 mm        | 510 mm    |
| 250 mm        | 255 mm    |

### Elongation gauge

A special service offered by Forbo Movement Systems involves applying reference measuring marks to the Siegling Extremultus flat belt when ordered (see Chapter 7.4). After elongating, check the elongation value using the elongation gauge after several turns.

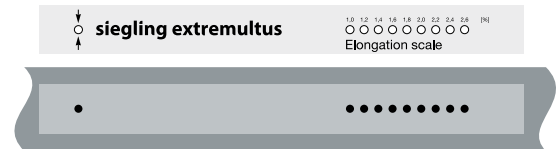

### Mechanical elongation measuring device

Use one of Forbo Movement Systems' mechanical elongation measuring devices to directly measure the elongation at fitting. Clamp the device to the belt edge and set the scale to zero. The elongation value can be read continuously during elongation.

Remove the device prior to turning the drive. It is only possible to check later on if the edges of the belt clamps were precisely marked prior to removing.

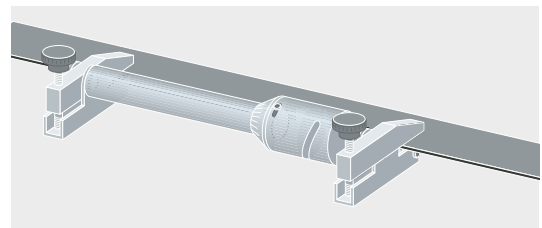

### Electronic vibration meter

A commercially available electronic vibration meter (accuracy < 1/10 Hz) can be used to indirectly determine the belt tension via the vibration behaviour of the belt strand. The frequency demonstrated by the flat belt at a defined elongation must be calculated prior to the measuring process.

A mechanical strike, manually striking with a hammer for example, makes the belt strand vibrate and its frequency is measured. The flat belt is stretched until the calculated vibration frequency is reached. Check the elongation by turning the drive several times and measuring the frequency again.

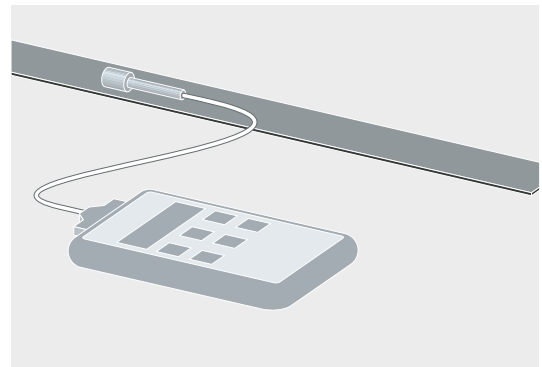

Take the running-in behavior (relaxation) of the tension member into account when fitting brand new flat belts for the first time. More detailed information can be found in the following section "Running-in behavior of plastic tension members". Depending on the tension member, set the frequencies at the beginning slightly higher than those calculated for run-in operation.

**Note:** Correctly calculating the frequency of the belt strand and reliably measuring the vibration of the Siegling Extremultus flat belt using the electronic vibration meter both require a high degree of technical knowledge and experience. Please contact Forbo Movement Systems to properly tension according to this method.

# 6.3 FITTING AND TENSIONING

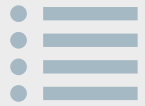

## Running-in behavior of plastic tension members

Plastics exhibit running-in behavior, also known as relaxation, under dynamic loads. In the case of flat belts with plastic tension members, this behavior presents in the form of a high shaft load when fitting the belt for the first time.

### Constant elongation

When fitting new Siegling Extremultus flat belts with a defined elongation, there is a high initial shaft load value  $F_{W\text{initial}}$ . Over the course of the initial operating hours, this shaft load falls to a steady value  $F_{W\text{steady}}$  that corresponds to the calculated dynamic shaft load  $F_{Wd}$ . The graph to the right illustrates the sample development of a Siegling Extremultus flat belt during the running-in phase.

$$c_{\text{initial}} = \frac{F_{W\text{initial}}}{F_{Wd}}$$

The ratio  $c_{\text{initial}}$  varies between the initial shaft load value and the steady value depending on the material and design of the tension member. In addition to various other factors, this ratio determines the duration of the running-in process and is thus extremely difficult to predict. As a general rule, at least 150,000 bending cycles (corresponding to 75,000 revolutions in a 2-pulley drive) should be applied to Siegling Extremultus flat belts before operating the machinery at full load.

### Constant pre-tension force

Pneumatic, spring or weight-loaded take-up units must tension the flat belts using at least the calculated dynamic shaft load  $F_{Wd}$ . The appropriate elongation at fitting  $\epsilon$  is only reached after a certain running-in period due to the running-in behavior of the tension members. The center distance increases slightly during the running-in period.

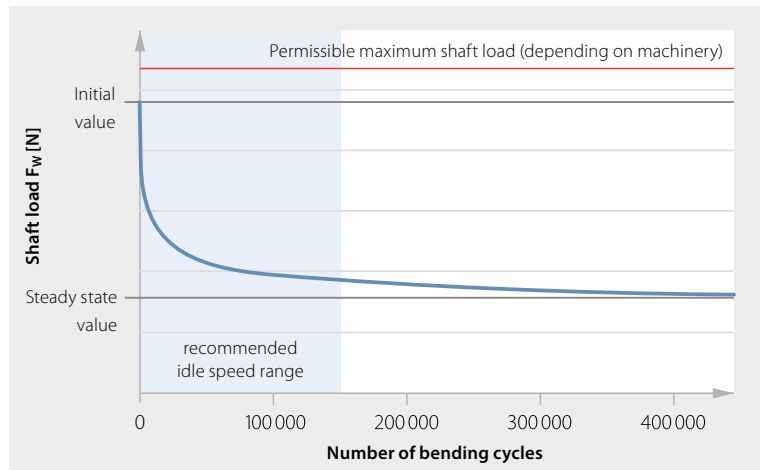

**Note:** The steady state value of the shaft load is the basis for calculating the power transmission of a flat belt. The higher initial shaft load value should be taken into account by the designer, at least when dimensioning the shaft bearings based on static loads.

| Line           | Tension member design | Running-in ratio $c_{\text{initial}}$ |
|----------------|-----------------------|---------------------------------------|
| Polyester line | Fabric                | 1.8                                   |
|                | Cord                  | 1.5                                   |
| Aramide line   | Fabric                | 1.4                                   |
|                | Cord                  | 1.5                                   |
| Polyamide line | Sheet                 | 2.2                                   |

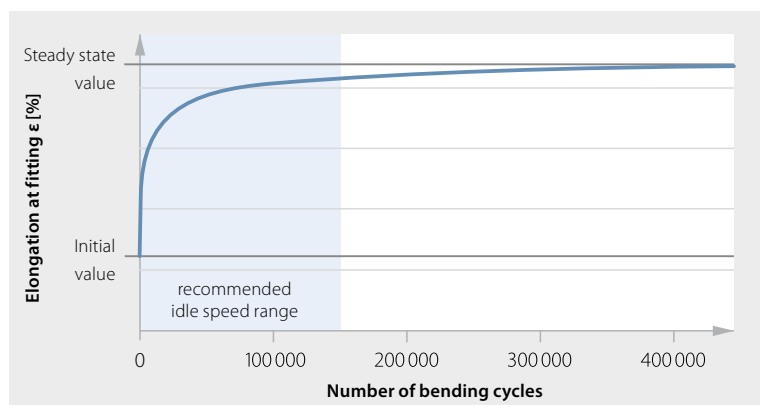

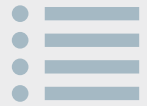

## Installing strong flat belts

When installing Siegling Extremultus flat belts with a high width-related shaft load  $F'_W$ , forces that are significantly higher than the calculated force values may be applied to the shafts and bearings during the initial fitting.

### Tensioning in two stages

Installing Siegling Extremultus flat belts with a high width-related shaft load can be problematic for bearing machine parts. The running-in behavior of the plastic tension member can cause the permissible load on the shafts and/or bearings of the machinery to be exceeded by the high initial value of the shaft load, causing damage to the machinery. In such cases, Forbo Movement Systems recommends following a two-stage tensioning method:

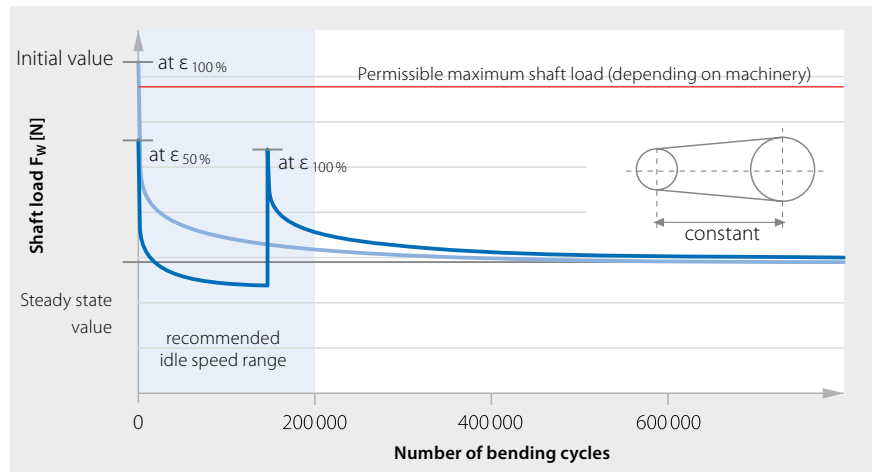

#### First stage:

Tension the Siegling Extremultus flat belt only to about 50% (in individual cases up to max. 70%) of the required elongation at fitting ( $\epsilon_{50\%} = 0.5 \cdot \epsilon$ ). The machinery should then be operated with low load at moderate speed. After approximately 150,000 bending cycles (corresponding to 75,000 revolutions in a 2-pulley drive) there should be no more significant changes in the shaft load (in some cases this point can occur earlier or somewhat later).

#### Second stage:

Now tension the Siegling Extremultus flat belt to the required elongation at fitting ( $\epsilon_{100\%} = \epsilon$ ) and run it in for another approx. 50,000 bending cycles (corresponding to 25,000 revolutions in a 2-pulley drive). The machinery can then be run safely in the full load range. The flat belt will continue running in during operation until it reaches the steady state value of the shaft load. No further action is necessary.

By using this two-stage tensioning method, it is possible to avoid exceeding the permissible maximum value of the shaft load ( $F_{W,max}$ ) for the machinery (shown in light grey in the graphic above). The two-stage tensioning method has no negative affect on the width-based shaft load  $F'_W$  of the Siegling Extremultus flat belt or on the maximum possible power transmission by the flat belt.

**Note:** Forbo Movement Systems strongly advises you against tensioning the flat belts in more than two stages, otherwise the shaft load-elongation behavior in the tension members can change, rendering the flat belt useless (dead tensioning the flat belt).



### Removing and re-fitting used flat belts

When a used flat belt is removed, it must have the same elongation as before when it is re-fitted and put back into operation.

We therefore recommend applying clear measuring marks to the flat belt or marking the position of the take-up unit before loosening the belt and removing it. When re-fitting the flat belt, you must restore the original measurement markings and the original position of the take-up unit.

When using an electronic vibration meter, determine the frequency of the belt strand in its original state of tension prior to loosening and set it again when re-fitting the belt. Due to measuring uncertainties, however, we recommend using measuring marks when tensioning the Siegling Extremultus flat belts during re-fitting.

Sufficiently relaxed flat belts generally do not display running-in behavior again when re-fitted.

**Note:** *A minimum window of time (>24 h) must be observed between removing and re-fitting the Siegling Extremultus flat belts so that the flat belts have time to slacken*

# 6.4 MAINTENANCE AND HANDLING

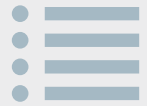

## Maintenance

In general, most Siegling Extremultus flat belts are maintenance-free.

### Maintenance of Siegling Extremultus leather surfaces

In the absence of regular care (or if care is excessive), the chrome leather layer loses its special properties. It should therefore be checked every two to three weeks.

When checking, the leather surface should be soft, greasy and matt. If the film of grease has noticeably worn down since last checked, applying Siegling Extremultus spray paste (item no. 880026) to the surface of the belt is recommended. If the surface of the leather is already hard, shiny and dry or is very soiled, use a soft wire brush to roughen it up beforehand. The pulleys should also be regularly cleaned during this service time. You should contact Forbo Movement Systems immediately if there is a noticeable change in the appearance of the belt, if unusual noises develop, or if there is excessive abrasion (e.g. red dust).

[www.forbo.com/movement](http://www.forbo.com/movement) > [Contact](#)

**Note:** Use only Siegling Extremultus spray paste for the chrome leather surfaces of the Siegling Extremultus flat belts!

Cleanliness around the machinery and the operating condition of the machinery can also play a role and should be checked at regular intervals.

Further information about this topic, you will find in [Chapter 11](#).

### Permissible operating temperatures

Forbo Movement Systems recommends that you adhere to the following guidelines to ensure the long-term operation of Siegling Extremultus flat belts:

The power elongation values of the tension members and the minimal drum diameter are within the limits of the operating temperatures indicated in the product data sheets as part of normal product tolerances. While it is possible to use them in colder temperatures, such as in refrigerated warehouses, they would require a larger roll diameter, specific friction coatings and laboratory trials conducted at Forbo Movement Systems.

**Note:** Please adhere to the information contained in the Siegling Extremultus data sheets regarding permissible operating temperatures. They may differ from the values indicated in the table on a case-by-case basis

| Product line      | Tension member design | Coatings  | Permissible operating [°C] |
|-------------------|-----------------------|---|----------------------------|
| Aramide line      | Fabric                | All   | -20/+70                    |
|                   | Cord                  | All   | -20/+60                    |
| Polyester line    | Fabric                | All   | -20/+70                    |
|                   | Cord                  | All   | -20/+60                    |
| Polyamide line    | Fabric                | All   | -20/+80                    |
|                   | Sheet                 | LL, LT and uncoated                             | -40/+80                    |
|                   | Sheet                 | All other coatings (GG, GT, TT, TG, RR, UU, NN) | -20/+80                    |
| Polyurethane line | Foil                  | All   | -20/+60                    |







# 7 SPLICING AND FABRICATION TECHNOLOGY

7.1 [General information](#)

7.2 [Splice types](#)

7.3 [Splicing](#)

7.4 [Fabrication options](#)

# 7.1 GENERAL INFORMATION

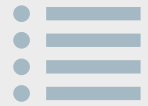

Precise endless splicing is a crucial prerequisite for all Siegling Extremultus flat belts manufactured as rolled material to ensure good tracking properties and a long service life.

Except for when using mechanical fasteners, the types of splicing are distinguished by the geometric shape of the ends of the flat belts, e.g. wedge splice, Z-splice and butt splice. Depending on the tension member material used, the prepared ends of the flat belt are either glued or melted together. However, melting the tension member materials together requires thermoplastic materials such as aramide, polyester and polyurethane.

Forbo Movement Systems keeps procedures and equipment technology in tune with current flat belt developments by co-operating closely with users and equipment manufacturers, offering compatible fabrication systems to provide effective and reliable endless splicing.

- high-quality tools with all the accessories
- detailed instruction manuals
- comprehensive service

Depending on the application and the customer's request, endless splices can be fabricated directly on-site within the machinery. Alternatively, we can take care of the endless splicing in one of our fabrication centers and then deliver the endlessly spliced Siegling Extremultus flat belts to you.

In addition to creating endless splices, our fabrication centers can also take care of perforations, profiles and belt edge processing for the Siegling Extremultus flat belts on request. As with splicing technology, it is necessary to check on a case-by-case basis whether the additional processing requested is technically feasible and approved by Forbo Movement Systems.

The following descriptions illustrate the basic nature of the various types of splices and their manufacture. If you require work instructions to create an endless splice for a specific Siegling Extremultus flat belt, please contact your local representative at Forbo Movement Systems:

[www.forbo.com/movement](http://www.forbo.com/movement) > [Contact](#)

We will be delighted to help.

Furthermore you will find more information at:

[www.forbo.com/movement](http://www.forbo.com/movement) > [Products](#) > [Splicing Tools](#)

## Preparation and splicing methods

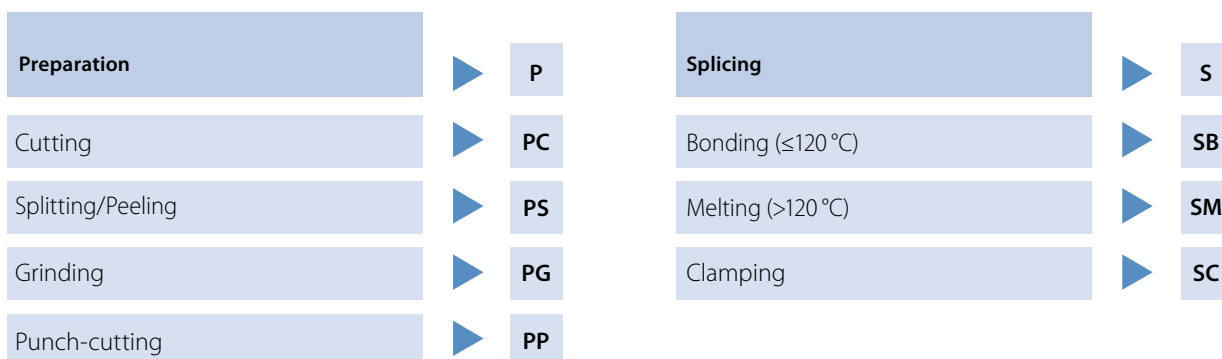

## 7.2 SPLICE TYPES

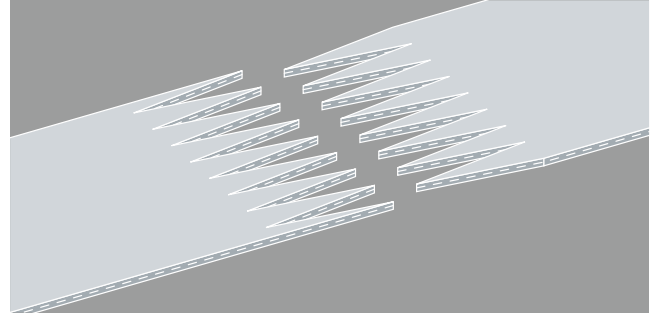
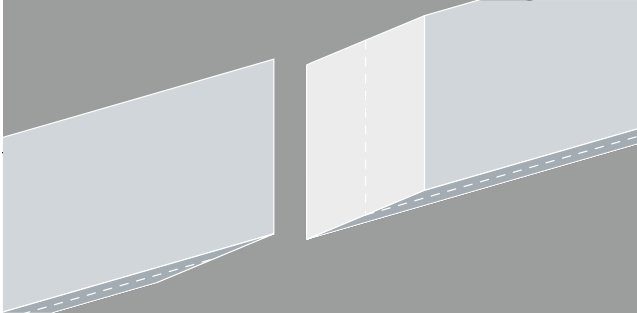
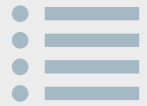

### Wedge splice

The wedge splice is a splice in which the ends of the cut flat belt are ground in the shape of a wedge. To join the ground ends of the flat belt, place the ends over one another, apply glue and place the ends in a heating device.

A bonding process is used for this splice, which, in turn, is used for Siegling Extremultus flat belts in the polyamide line. The flat belts are generally cut and ground at 90° or 60° angles. The splicing length can be varied based on the incline of the wedge:

- 3.5 mm : 100 mm
- 4.5 mm : 100 mm

#### Preparation

- Wedge-shaped grinding of the belt ends using the appropriate preparation tools

#### Bonded endless splicing

- Align and clamp the prepared belt ends, remove the hold-down bar with the clamped end of the splice
- Apply adhesive(s) to the splicing area in accordance with the belt structure and the splicing data sheet
- Replace the hold-down bar with the clamped end of the splice, insert the shim bars
- Glue/heat the splice ( $\leq 120^{\circ}\text{C}$ ) and apply pressure with a defined holding time

**Note:** Depending on the surface pattern of the belt, structural mesh, levelling mats etc. must be inserted above or below the belt (see splicing data sheet).

### Z-splice

To produce a Z-splice, an appropriate punching machine punches the ends of the cut flat belt in the shape of a Z. The punched ends then slide together and are joined using a heating device.

As this is a melt splice it is only permitted for thermoplastic materials (polyester, aramide and polyurethane lines as well as some products from the polyamide line with fabric tension members (only with U foil)). The Z-splices for Siegling Extremultus flat belts are available in four different sub-types that differ in the length and/or width of the Z-edges:

- 35 x 5.75 mm                      – 35 x 11.5 mm
- 70 x 11.5 mm                      – 110 x 11.5 mm

#### Preparation

- Z-shaped punching of the belt ends with hand punches or punching devices

#### Melting process for endless splicing

- Insert texture foil into the splice guide (replicates texture and allows outgassing of plastics)
- Insert belt ends (including U foil if necessary) precisely into the splice guide
- Fit texture foil to the splicing area (replicates texture and allows for outgassing of plastics)
- Insert the splice guide into a heating device, melt using heat ( $> 120^{\circ}\text{C}$ ) and pressure with a defined holding time

## 7.2 SPLICE TYPES

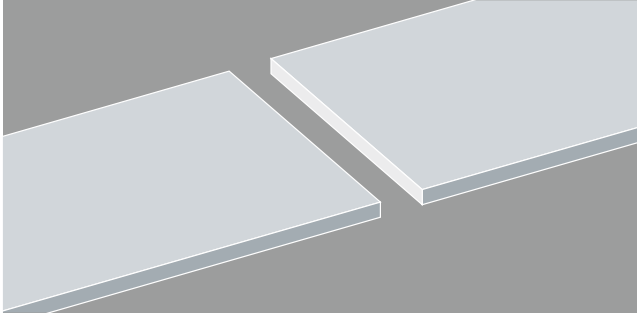

### Butt splice

In the case of butt splices, the ends of the flat belt must first be perfectly aligned at a 90° angle and cut straight to length. The ends are then melted and pressed into one another.

Forbo Movement Systems also produces butt splices with different angles for special applications.

A melting process is always used to create butt splices. Due to the minimal splicing surface between the ends of the flat belt, this type of splice is only suitable for applications in which relatively minimal forces act on the flat belt. Hence butt splices are only used to join Siegling Extremultus flat belts of the polyurethane line.

#### Preparation

- Cut belt ends parallel

#### Melting process for endless splicing

- Position the ends of the flat belt on opposite sides of the heating plate
- Melt the ends of the flat belt together
- Remove the heating plate and press the ends together

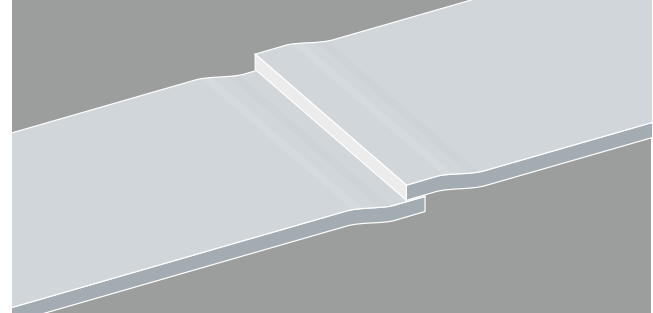

### Overlap splice

When executing an overlap splice, the ends of the flat belt must first be at exactly a 90° angle and cut exactly to length. The ends are then laid on top of one another with approximately 2 mm of overlap and then joined in a heating device. Forbo Movement Systems also produces overlap splices with other angles for special applications.

A melting process is always used to create an overlap splice. Although the splicing surface is larger than that of a butt splice, it is still extremely small compared to a wedge or Z-splice. For this reason the overlap splice, like the butt splice, is also only suitable for Siegling Extremultus flat belts in the polyurethane line.

#### Preparation

- Cut belt ends parallel

#### Melting process for endless splicing

- Insert texture foil into a splice guide (replicates texture and allows outgassing of plastics)
- Insert belt ends precisely into the splice guide
- Fit texture foil to the splicing area (replicates texture and allows for outgassing of plastics)
- Insert the splice guide into a heating device, melt using heat (> 120°C) and pressure with a defined holding time

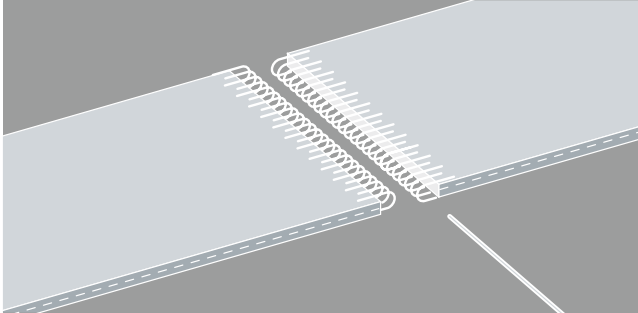

## Mechanical fasteners

Mechanical fasteners are wire clamps or hinge designs that are pressed into the ends of the Siegling Extremultus flat belts and then held together with a connecting wire or pin.

Mechanical fasteners are generally available in metal and plastic.

This type of splicing was developed at the start of industrialization and was the only viable option to adequately join flat belts at the time. Nowadays, mechanical fasteners have become much more delicate due to the high-strength materials. In addition, the splicing techniques described above represent other options for joining flat belts that have been added over time. That is why, if at all possible, mechanical fasteners are only used for Siegling Extremultus flat belts as a special solution and only if expressly requested.

### Preparation

- Cut belt ends vertically at 90° angle
- Affix the fasteners to the belt ends

### Endless splicing with mechanical fasteners

- Place the belt ends together so that the eyes of the fasteners are aligned in a row
- Guide the connecting wire/pin through the eyes of the fasteners

# 7.3 SPLICING

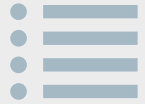

Splices in flat belts are largely created by hand. Only individual steps can be automated. That is why errors can easily occur when creating splices. These errors can be avoided by following the procedure described below.

There are splicing instructions (1) for every splicing method (see [Chapter 7.2](#)) for Siegling Extremultus flat belts. The instructions describe the workflow starting with the preparation of the belt material right down to the removal of the finished splice. The splicing instructions are supplemented by splicing data sheets (2). They contain precise descriptions of the heating process for each product, including indications for time and temperature as well as the names of auxiliary splicing materials (e.g. structural mesh, adhesives). The splicing instructions and data sheets can be called up from the in-house splicing database B\_Rex/Splice\_It (3).

Avoiding errors when creating splices starts by carefully reading the splicing instructions and data sheets. In accordance with these documents, prepare the required accessories and check that they function properly.

While some accessories, such as the splice guide, are easy to check, accessories prone to wear and tear require special attention. Is the adhesive still usable, for example? Is the structural mesh clean and unworn?

The belt material must also be carefully prepared. In addition, the length must be correctly determined (see [Chapter 5.2](#)) and cut. The belt width must also be cut accurately. Finally, it is essential to punch, cut and grind the immediate splicing area. Ensure that you are using suitable cutting blades, abrasives and grinding machines.

Check the following, depending on the type of splice:  
 Wedge splice – Are the belt ends grinded at uniform angles?  
 Z-splice – Are the Z-edges completely punched through and straight?  
 Are the belt ends aligned in a row?

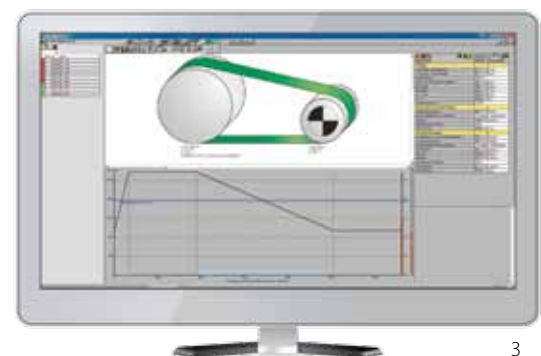
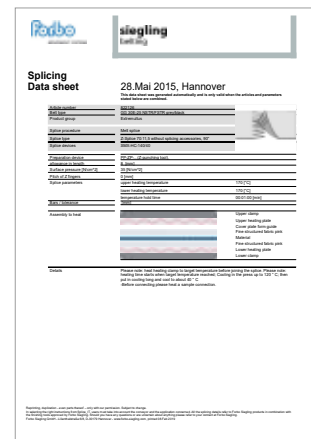
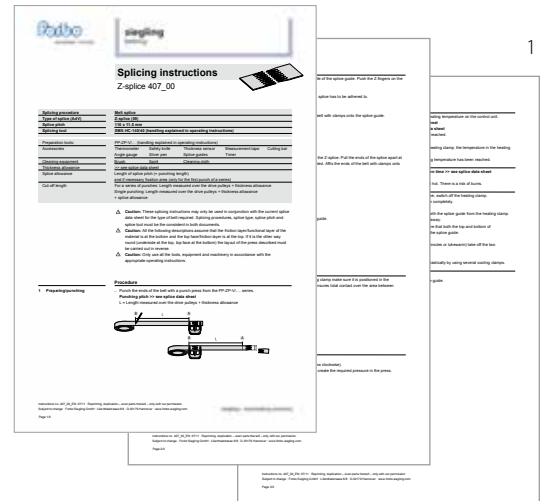

If the preparatory steps have been carried out precisely, the key to a good splice is applying the adhesive to the belt ends (for wedge splices) and/or observing the parameters indicated: pressure, temperature, time.

The pressure is usually specified by the heating device. The temperature and time parameters, on the other hand, can be adjusted by the user. They can be taken from the splicing data sheet and set accordingly on the heating device (4).

Forbo Movement Systems recommends always creating a test splice in order to try out all of the steps in the splicing process.

After the belt has cooled (see splicing instructions and data sheet) and has been removed from the splice guide, the splice edges can be straightened.

The belt is now ready for use. Please follow the information in [Chapter 6](#) regarding the handling of flat belts:

- Storage
- Condition of machinery
- Fitting and tensioning
- Care and handling

If you require help creating an endless splice for a specific Siegling Extremultus flat belt, please contact your local Forbo Movement Systems representative:

[www.forbo.com/movement](http://www.forbo.com/movement) > [Contact](#)

We will be pleased to help you.

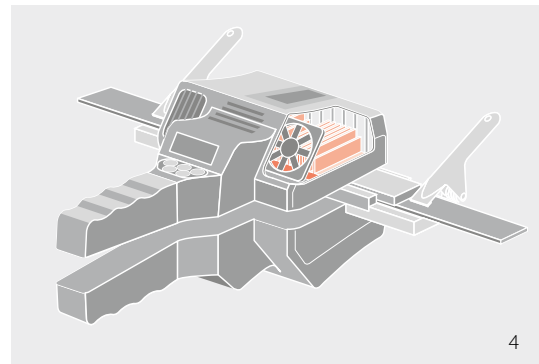

## 7.4 FABRICATION OPTIONS

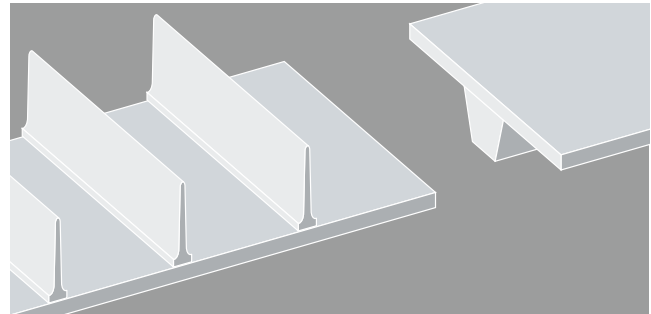
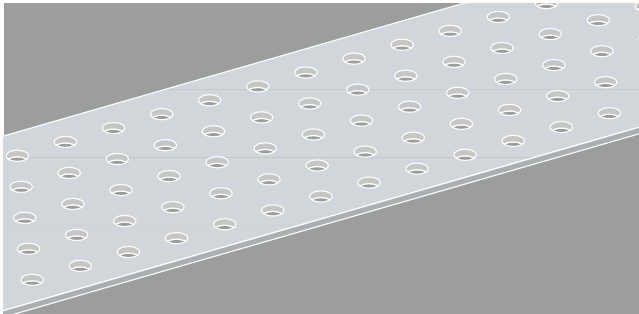
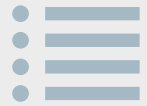

In addition to creating endless splices, another area of fabrication involves adding other features to the Siegling Extremultus flat belts. “Other features” refers here to applying profiles, creating perforations and the special processing of belt edges as well as applying labels.

Not all of the other features make sense or are technically feasible for all Siegling Extremultus flat belts so please contact your local representative to discuss any special requests in detail:

[www.forbo.com/movement](http://www.forbo.com/movement) > [Contact](#)

We will be delighted to help.

### Profiles

Profiles are usually not welded to the extremely thin Extremultus belts. Profiles are not common, particularly with power transmission belts. Generally speaking, longitudinal profiles can be used for better control and lateral profiles can be used depending on the top coating of the flat belt. However, profiles are only used with flat belts involved in conveyor tasks.

### Perforations

Any conceivable perforation can be made according to customer requirements. The perforations are usually made on Siegling Extremultus flat belts that are used as vacuum belts. Forbo Movement Systems supplies these belts mainly to the printing and pulp and paper industry.

### Belt edge processing

Belt edge processing on Siegling Extremultus flat belts with fabric tension members is possible in principle but is only used in special cases e.g. in the food industry or with textile machines. Fray free operation is the main goal, as well as offering some protection to the tension member against the flat belt running up against machinery parts during operation.

### Belt edge designs

The “sawn edge” on heavy belts in the polyamide line is a special type of belt edge design. This type of belt edge design makes sense if the flat belt is fed in from the side or must be moved laterally in transmissions during operation as the sawn edge is considerably more robust than the cut edge of the polyamide tension member in the case of lateral run-up.



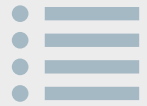

## Labelling

For many applications, applying lettering and images is desirable. Forbo Movement Systems boasts a variety of technical methods to choose from depending on the application and scope of the labelling.

- Films: heating films on the belt surface
- Printing: applying particles to the belt surface, e.g. inkjet printing
- Laser labelling: using a laser to change the color of the surface

Labelling essentially performs the following functions:

### Automation

In automated processes, markings can be recognized by optical sensors. The conveyed product is precisely positioned or precisely controlled during processing.

### Safety

High contrast markings ensure good visibility on a moving belt, contributing to accident prevention.

### Advertising

The application of any text or image provides customers with eye-catching and unmistakable branding.

### Identification

Important information such as technical data, belt properties and order codes can be applied to make it easier for the user to reorder the belt and comply with legal regulations.

Laser labelling in particular offers many advantages. The labels are extremely resistant, accurately positioned and highly refined. It is also economical, even for small print runs.

Laser labelling is ideal for belts that are in direct contact with unpackaged food in accordance with the FDA regulation 21 CFR as well as the European regulation (EU) 10/2011 and (EC) 1935/2004.

Contact your local representative for more information about belt labelling:

[www.forbo.com/movement](http://www.forbo.com/movement) > Contact

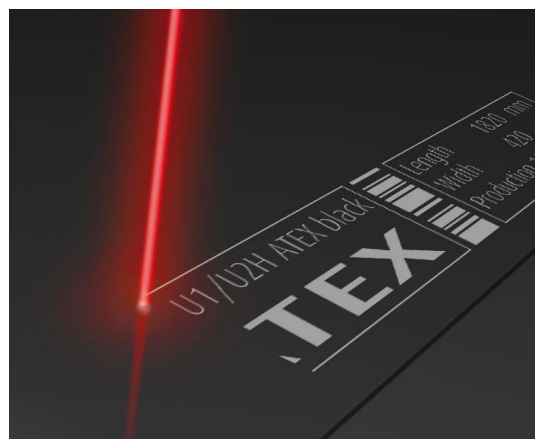
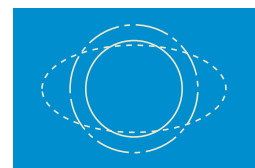
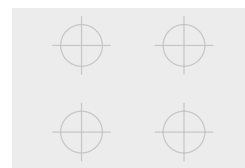
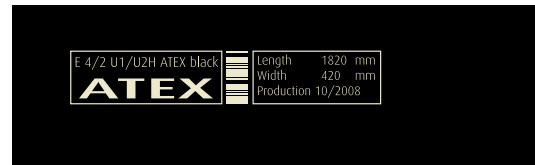

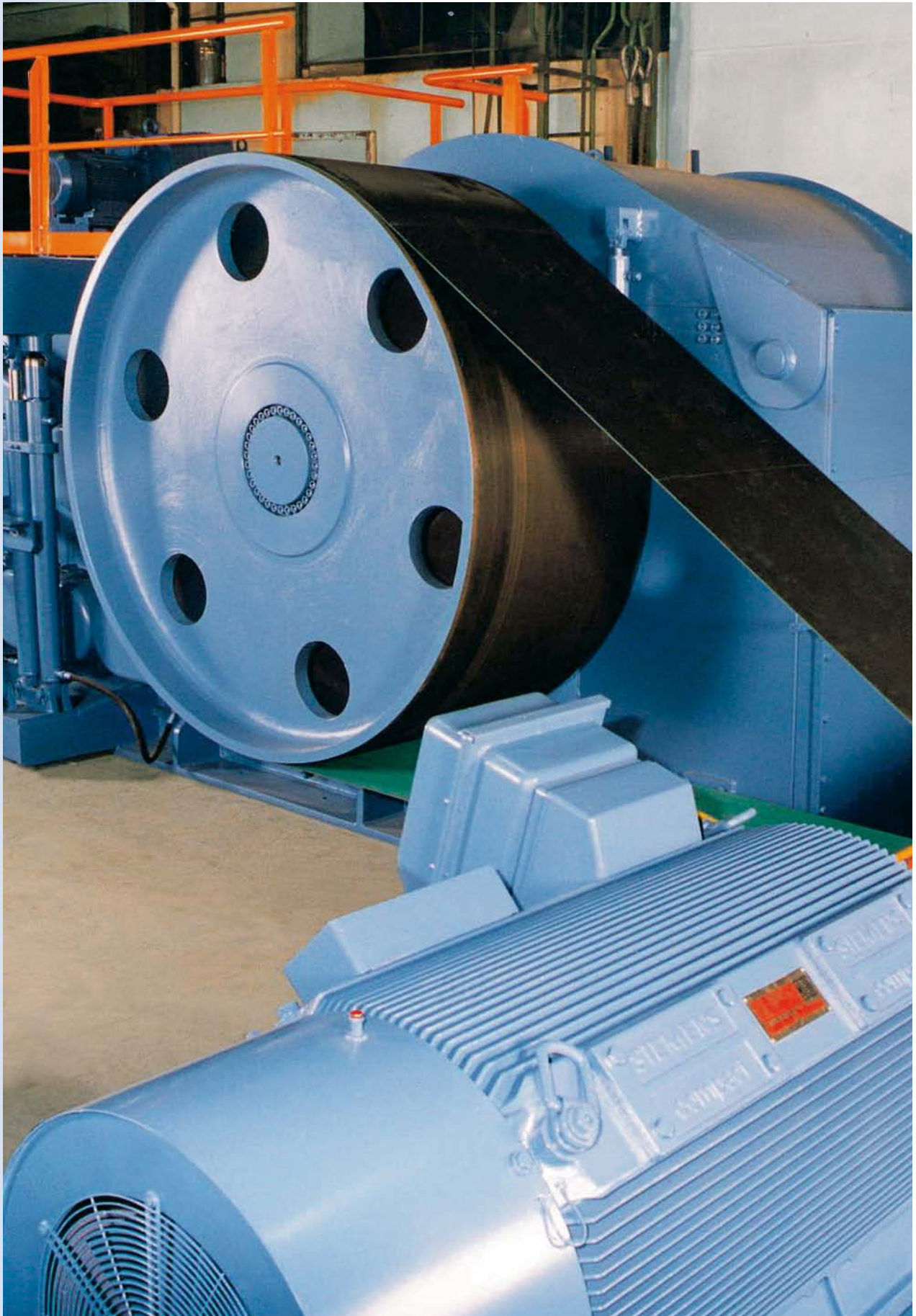



# 8 PULLEYS

8.1 [Pulley geometries](#)

8.2 [Dimensions and quality of pulleys](#)

8.3 [Use of crowned pulleys](#)

# 8.1 PULLEY GEOMETRIES

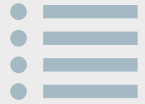

A huge advantage with flat belt drives is the simple geometry of the pulleys used, unlike drives with V-belt and V-ribbed belts.

Forbo Movement Systems recommends the use of cylindrical or crowned pulleys. In special cases (e.g. a cone drive), conical pulleys are also permitted.

Avoid sharp edges on the pulleys at all costs. For this reason, pulleys with trapezoidal, cylindrical-conical or even pointed designs are not suitable.

Also avoid excessive crowning to guarantee maximum belt durability. The crown height values  $h$  recommended by Forbo Movement Systems are listed in the following table.

Using pulleys in line with ISO 22 ensures belt durability, optimal power transmission, good belt tracking and low shaft loads.

**Note:** For pulley diameters  $> 2000$  mm, we recommend contacting Forbo Movement Systems applications engineers regarding the crown height.

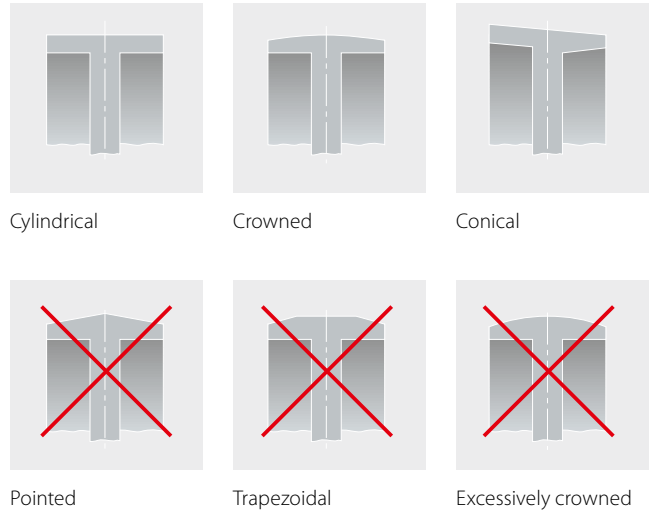

Cylindrical

Crowned

Conical

Pointed

Trapezoidal

Excessively crowned

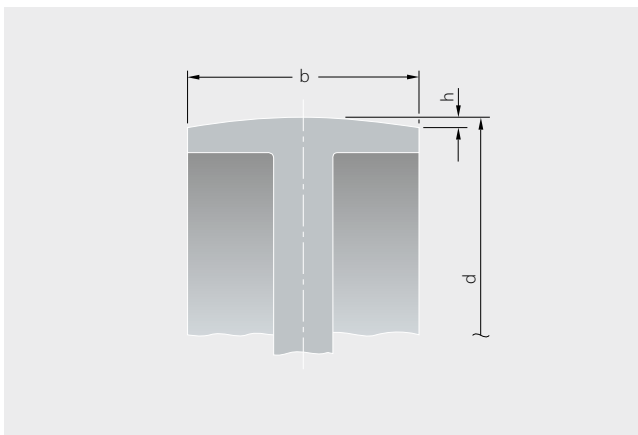

## Crown height „h“ as per ISO 22

| Pulley diameter d [mm] |    |      | Crown height h [mm]            |            |
|------------------------|----|------|--------------------------------|------------|
|                        |    |      | for pulley width<br>b ≤ 250 mm | b > 250 mm |
| 40                     | to | 112  | 0.3                            |            |
| 125                    | to | 140  | 0.4                            |            |
| 160                    | to | 180  | 0.5                            |            |
| 200                    | to | 224  | 0.6                            |            |
| 250                    | to | 280  | 0.8                            |            |
| 315                    | to | 500  | 1.0                            |            |
| 560                    | to | 710  | 1.2                            |            |
| 800                    | to | 1000 | 1.2                            | 1.5        |
| 1120                   | to | 1400 | 1.5                            | 2.0        |
| 1600                   | to | 2000 | 1.8                            | 2.5        |

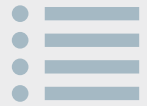

### Pulleys with flanges

In some cases it may be necessary to use flanges on the pulleys. As a general rule, however, Forbo Movement Systems advises against the use of flanged pulleys.

If the use of flanged pulleys is unavoidable, ensure that the face of the pulley is crowned in accordance with ISO 22 (see table on previous page). In addition, the inner edges of the flanges must feature an undercut of 5° and all edges must be rounded. These measures ensure that the flat belt never touches the flanged pulley as this can damage the flat belt.

**Note:** Do not use flanged pulleys to control the flat belt!

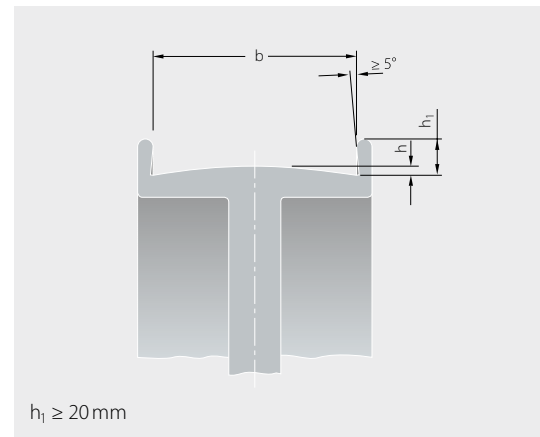

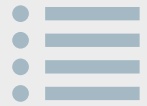

## 8.2 DIMENSIONS AND QUALITY OF PULLEYS

The width of the pulley  $b$  is calculated from the width of the flat belt " $b_0$ " used. Following ISO 22, Forbo Movement Systems recommends the minimum pulley widths " $b$ " for the line of belt widths (see table).

For pulley width which are not shown in this table following formula can be used:

$$b \geq 1.1 \cdot b_0$$

The minimum diameters of the pulleys permitted for use in the machinery depend on the flat belts used and are indicated in the respective Siegling Extremultus flat belt product data sheets.

In principle, the pulley faces should have an average roughness of  $R_a \leq 6.3 \mu\text{m}$  (according to DIN EN ISO 4287 and DIN EN ISO 4288). Surfaces with an average roughness of  $R_a \leq 3.2 \mu\text{m}$ , however, are not recommended, especially as drive pulleys. The risk of slippage exists here, potentially leading to a decrease in the transmission of power.

Normal pulleys can be used for speeds up to  $v_{\text{max}} = 40 \text{ m/s}$ . Special pulleys must be used for higher speeds (e.g. steel, counter-balanced).

| $b_0$ [mm] | $b$ [mm] |
|------------|----------|
| 20         | 25       |
| 25         | 32       |
| 30         | 40       |
| 35         | 40       |
| 40         | 50       |
| 45         | 50       |
| 50         | 63       |
| 55         | 63       |
| 60         | 71       |
| 65         | 71       |
| 70         | 80       |
| 75         | 90       |
| 80         | 90       |
| 85         | 100      |
| 90         | 100      |
| 95         | 112      |
| 100        | 112      |
| 120        | 140      |
| 140        | 160      |
| 160        | 180      |

| $b_0$ [mm] | $b$ [mm] |
|------------|----------|
| 180        | 200      |
| 200        | 225      |
| 220        | 250      |
| 250        | 280      |
| 280        | 315      |
| 300        | 315      |
| 320        | 355      |
| 350        | 400      |
| 380        | 400      |
| 400        | 450      |
| 450        | 500      |
| 500        | 560      |
| 550        | 630      |
| 600        | 630      |
| 650        | 710      |
| 700        | 800      |
| 750        | 800      |
| 800        | 900      |
| 900        | 1000     |
| 1000       | 1120     |



# 8.3 USE OF CROWNED PULLEYS

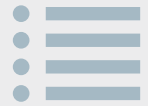

## 2-pulley drives

As a general rule, both pulleys in a 2-pulley drive should be designed with a crown height as per ISO 22. However, for drives with horizontal shafts and ratios of more than 1:3, the smaller pulley can be cylindrical.

## Multi-pulley drives

In multi-pulley drives, only the pulleys that bend the flat belts in the same direction should be crowned. The pulleys located on the "inside" are generally best suited for this.

With shorter belt lengths, however, it is often sufficient to crown only the largest pulley to ensure reliable belt tracking.

In example 1, we recommend crowning pulleys a, c, e, f and g. With shorter flat belts it is sufficient to crown only a and e.

In example 2, we recommend crowning pulleys a, c and d. For short belt lengths, a crowned version of "a" is sufficient.

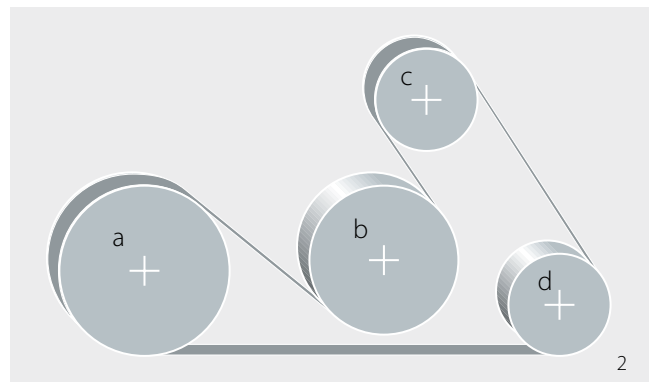
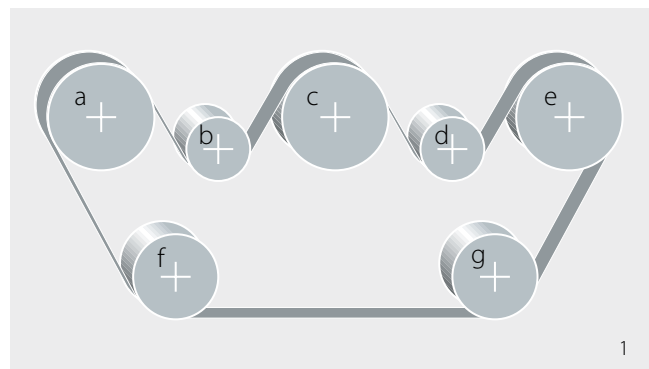

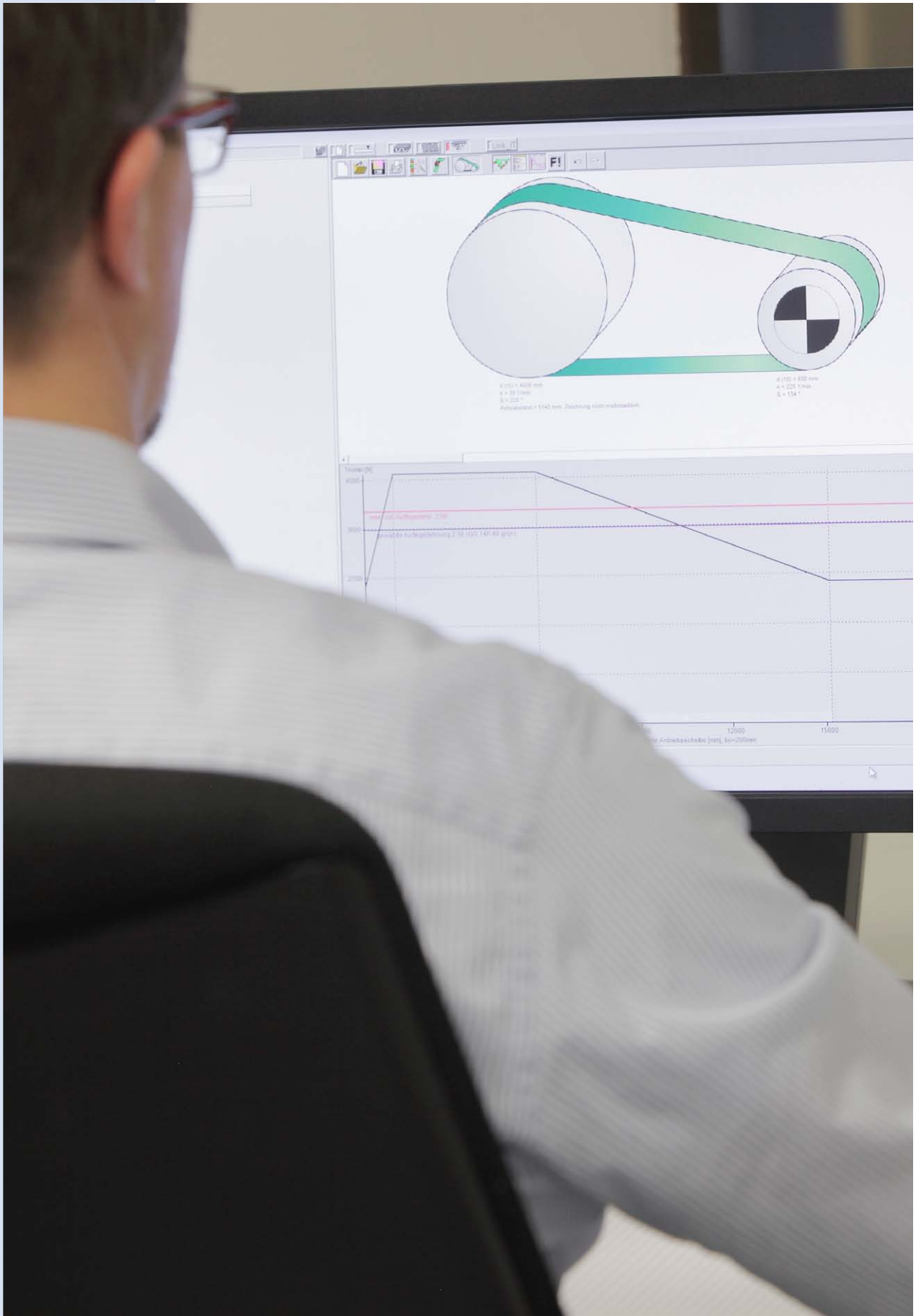





# 9 CALCULATION OF POWER TRANSMISSION BELTS

- 9.1 [General information](#)
- 9.2 [Power transmission on flat belts](#)
- 9.3 [Terminology](#)
- 9.4 [Calculation method](#)
- 9.5 [Operating factor  \$c\_2\$](#)
- 9.6 [Basic elongation at fitting  \$c\_4\$](#)
- 9.7 [Elongation allowance for centrifugal force  \$c\_5\$](#)
- 9.8 [Vibration calculation](#)
- 9.9 [Calculation example](#)

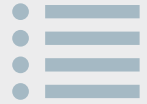

# 9.1 GENERAL INFORMATION

This chapter contains up-to-date formulae, figures and recommendations based on our longstanding experience. They apply to power transmission between friction layers G elastomer, or chrome leather and steel/cast iron pulleys. The results of these calculations may however vary from those provided by our B\_Rex calculator ([see Chapter 4.5](#)).

These deviations are a result of the fundamentally different approaches: while B\_Rex is based on empirical measurements and requires a detailed description of the machinery, the calculation methods shown here are based on general, simple physical formulae and derivations, supplemented by certain safety factors (e.g.  $c_2$ ).

In most cases, the safety factor in calculations in this brochure will be greater than in the corresponding B\_Rex calculation.

**Note:** *Siegling Extremultus flat belts from the polyurethane line are not primarily designed for transmitting power and the relevant data cannot be calculated using these formulae*

# 9.2 POWER TRANSMISSION ON FLAT BELTS

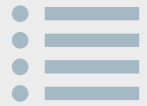

For force-fit transmission of a given torque  $M$  and thus an effective pull  $F_U$ , the flat belt must be pulled tight against the pulley. This creates a force which acts on both the tight and slack side of the belt ( $F_1$  and  $F_2$ ) and acts as a reaction force on the pulley shafts. This force is known as the shaft load  $F_W$  (see also Chapter 2.6).

The friction helps transfer the effective pull  $F_U$  from the driving pulley to the driven pulley via the contact between the flat belt and the pulley. In so doing, the pull  $F_1$  and thus the elongation on the tight side of the belt is higher than the pull  $F_2$  and the elongation in the slack side of the belt. These elongation differences in the flat belt are compensated for by the slip  $s$ .

As shown in the diagram below, there are three slip areas: the creep area, the creep and slippage area and the slippage area. In this case, slippage refers to the flat belt gliding, or slipping, on the pulley. Avoid operating the flat belts in the slippage area at all costs as this significantly reduces the service life of the flat belt. Neither can slippage be fully eliminated when operating in the creep and slippage area so this operating area should also be avoided.

Creep, however, means that the elastic material behaviour of the flat belt compensates for the force and elongation differences in the belt strands ( $F_1$  and  $F_2$ ) generated by the effective pull  $F_U$ . There is no excessive wear to the flat belt as a result.

Siegling Extremultus flat belts (polyamide line) are designed to reach their nominal effective pull  $F_{UNenn}$  at a defined elongation at fitting, the nominal elongation at fitting  $\epsilon_{Nenn}$ , and at a slip value of  $s = 0.6\%$ . If the flat belts are operated at their intended operating point, they are always working safely in the creep area. This area covers a slip of about  $s = 0.9\%$ , meaning that in extreme cases the Siegling Extremultus flat belts can transmit up to 150% of their nominal effective pull  $F_{UNenn}$ . This ensures that Siegling Extremultus flat belts always reliably transmit power to the customer's complete satisfaction. Different applications require different flat belt widths. In order to categorize the flat belts, the nominal effective pull in the data sheet is indicated as width-based nominal effective pull  $F'_{UNenn}$  – based on a width of 1 mm.

**Note:** Slippage areas depend on the material of the flat belt used. Therefore, Siegling Extremultus flat belts in the aramide and polyester lines have different slip values than flat belts in the polyamide line.

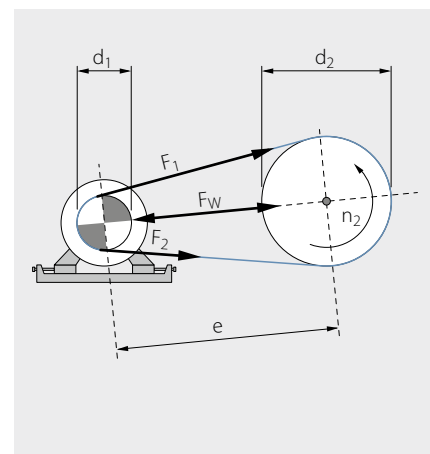
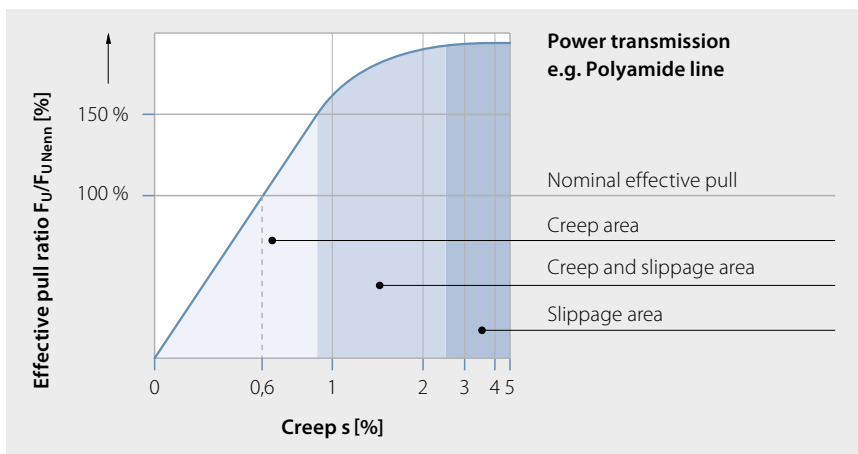

## 9.3 TERMINOLOGY



| Abbreviation          | Unit              | Designation   |
|-----------------------|-------------------|---|
| b                     | mm                | Width of pulley ring  |
| b <sub>0</sub>        | mm                | Width of the flat belt  |
| c <sub>2</sub>        | –                 | Operating factor  |
| c <sub>4</sub>        | %                 | Basic elongation at fitting   |
| c <sub>5</sub>        | %                 | Elongation allowance for centrifugal force                          |
| c <sub>initial</sub>  | –                 | Running-in ratio  |
| c <sub>R</sub>        | N/m               | Spring constant of the flat belt                                    |
| d <sub>1</sub>        | mm                | Diameter of the driving pulley                                      |
| d <sub>2</sub>        | mm                | Diameter of the driven pulley                                       |
| d <sub>small</sub>    | mm                | Diameter of the smallest pulley                                     |
| e                     | mm                | Distance between shafts/pulleys                                     |
| F <sub>1</sub>        | N                 | Tensile force – tight side of the belt                              |
| F <sub>2</sub>        | N                 | Tensile force – slack side of the belt                              |
| F <sub>B</sub>        | N                 | Reference force   |
| F <sub>U</sub>        | N                 | Effective pull to be transmitted                                    |
| F' <sub>U</sub>       | N/mm              | Width-based effective pull  |
| F <sub>UNenn</sub>    | N                 | Nominal effective pull at nominal elongation at fitting             |
| F' <sub>UNenn</sub>   | N/mm              | Width-based nominal effective pull at nominal elongation at fitting |
| F <sub>W</sub>        | N                 | Shaft load  |
| F' <sub>W</sub>       | N/(mm · %)        | Width-related shaft load at 1% elongation at fitting                |
| F <sub>Wd</sub>       | N                 | Dynamic shaft load  |
| F <sub>Winitial</sub> | N                 | Initial value of the shaft load                                     |
| F <sub>Wmax</sub>     | N                 | Permissible maximum shaft load (depending on machinery)             |
| F <sub>Ws</sub>       | N                 | Static shaft load   |
| f <sub>1</sub>        | Hz                | Transversal eigenfrequency tight side of belt                       |
| f <sub>2</sub>        | Hz                | Transversal eigenfrequency slack side of belt                       |
| f <sub>err</sub>      | Hz                | Exciter frequency   |
| h                     | mm                | Crown height  |
| J <sub>1</sub>        | kgm <sup>2</sup>  | Mass moment of inertia of the driving pulley                        |
| J <sub>2</sub>        | kgm <sup>2</sup>  | Mass moment of inertia of the driven pulley                         |
| l                     | mm                | Geometrical belt length   |
| l <sub>1</sub>        | mm                | Arc length on the driving pulley                                    |
| l <sub>2</sub>        | mm                | Arc length on the driven pulley                                     |
| l <sub>s</sub>        | mm                | Freely vibrating belt length  |
| M                     | Nm                | Torque  |
| m'                    | kg/m <sup>2</sup> | Weight per surface unit of the flat belt                            |
| m' <sub>R</sub>       | kg/m              | Weight per metre of the flat belt                                   |
| n <sub>1</sub>        | 1/min             | Speed of the driving pulley   |
| n <sub>2</sub>        | 1/min             | Speed of the driven pulley  |
| P                     | kW                | Power to be transmitted   |
| v                     | m/s               | Belt speed  |
| z <sub>err</sub>      | –                 | Number of excitation cycles per belt revolution                     |
| β <sub>1</sub>        | mm                | Arc of contact at the driving pulley                                |
| β <sub>2</sub>        | mm                | Arc of contact at the driven pulley                                 |
| ε                     | %                 | Elongation at fitting   |
| ε <sub>Nenn</sub>     | %                 | Nominal elongation at fitting                                       |

# 9.4 CALCULATION METHOD



Known are: P [kW],  $d_1$  [mm],  $n_1$  [1/min],  $d_2$  [mm] and e [mm]

|   |   |
|---|---|
| <p>1 Arc of contact <math>\beta_1</math> and <math>\beta_2</math></p>   | $\beta_1 = 2 \cdot \arccos \left( \frac{d_2 - d_1}{2e} \right) \quad [^\circ]$ $\beta_2 = 2 \cdot \arccos \left( \frac{d_1 - d_2}{2e} \right) \quad [^\circ]$   |
| <p>2 Belt speed v<br/>Effective pull to be transmitted <math>F_U</math></p>   | $v = \pi \cdot \frac{d_1}{1000} \cdot \frac{n_1}{60} \quad [\text{m/s}]$ $F_U = \frac{P \cdot 1000}{v} \quad [\text{N}]$  |
| <p>3 Reference force <math>F_B</math><br/>operating factor <math>c_2</math></p>   | $F_B = F_U \cdot c_2 \quad [\text{N}]$ <p>Read off <math>c_2</math> from the "Operating factor" table (<a href="#">see Chapter 9.5</a>)</p>   |
| <p>4 Width-based Effective pull <math>F'_U</math><br/>width-based Nominal effective pull <math>F'_{UNenn}</math><br/>Basic elongation at fitting <math>c_4</math><br/>Flat belt preselection</p>  | <p>In the diagram of <math>d_{small}</math> going vertically to the top until it intersects with <math>\beta</math>, read off <math>F'_U</math>, to the left and <math>c_4</math> and <math>F'_{UNenn}</math> to the right.<br/>A suitable product is preselected based on the width-based nominal effective pull of <math>F'_{UNenn}</math>.</p>   |
| <p>5 Width of the flat belt <math>b_0</math></p>  | $b_0 = \frac{F_B}{F'_U} \quad [\text{mm}]$  |
| <p>6 Arc length at the driving pulley <math>l_1</math> and driven pulley <math>l_2</math><br/>Freely vibrating length <math>l_s</math><br/>Geometrical belt length <math>l</math></p>   | $l_1 = \pi \cdot \frac{d_1}{2} \cdot \frac{\beta_1}{180} \quad [\text{mm}]$ $l_2 = \pi \cdot \frac{d_2}{2} \cdot \frac{\beta_2}{180} \quad [\text{mm}]$ $l_s = \sqrt{e^2 - \frac{(d_2 - d_1)^2}{4}} \quad [\text{mm}]$ $l = l_1 + l_2 + 2 \cdot l_s \quad [\text{mm}]$ <p>Note: The length of the flat belt to order depends on the elongation at fitting (<a href="#">see Chapter 5.2, and Chapter 6.3</a>)</p>  |
| <p>7 Elongation at fitting <math>\epsilon</math><br/>Elongation allowance for centrifugal force <math>c_5</math></p>  | $\epsilon = c_4 + c_5 \quad [\%]$ <p>Read off <math>c_5</math> from the tables "Elongation allowance for centrifugal force" for the selected Siegling Extremultus flat belt (<a href="#">Chapter 9.7</a>)</p>   |
| <p>8 Shaft load <math>F_W</math><br/>At a standstill (static) <math>F_{Ws}</math><br/>While operating (dynamic) <math>F_{Wd}</math><br/>Initial value of shaft load <math>F_{Winitial}</math><br/>Running in ratio <math>c_{initial}</math></p>   | $F_{Ws} = \epsilon \cdot F'_w \cdot b_0 \quad [\text{N}]$ $F_{Wd} = c_4 \cdot F'_w \cdot b_0 \quad [\text{N}]$ $F_{Winitial} = c_{initial} \cdot \epsilon \cdot F'_w \cdot b_0 \quad [\text{N}]$ <p>Note: Read off <math>F'_w</math> from the data sheet (<a href="#">see Chapter 2.5</a>)</p> <p>Read off <math>c_{initial}</math> from the table Running-in ratio in <a href="#">Chapter 6.3</a></p>  |
| <p>9 Vibration calculation<br/>exciter frequency <math>f_{err}</math><br/>Weight per meter of the flat belt <math>m'_R</math><br/>Belt force on tight side of the belt <math>F_1</math><br/>Belt force on slack side of the belt <math>F_2</math><br/>Transversal eigenfrequency:<br/>on the tight side of the belt <math>f_1</math><br/>on the slack side of the belt <math>f_2</math></p> | $f_{err} = \frac{n}{60} \cdot z_{err} \quad [\text{Hz}]$ $m'_R = m' \cdot \frac{b_0}{1000} \quad [\text{kg/m}]$ $F_1 = \frac{F_{Ws} + F_U}{2} \quad [\text{N}]$ $F_2 = \frac{F_{Ws} - F_U}{2} \quad [\text{N}]$ $f_1 = \frac{1000}{l_s} \sqrt{\frac{F_1}{4 \cdot m'_R}} \quad [\text{Hz}]$ $f_2 = \frac{1000}{l_s} \sqrt{\frac{F_2}{4 \cdot m'_R}} \quad [\text{Hz}]$ <p>Use the speed of the pulley with the highest mass imbalance for n.<br/>Read off <math>m'</math> from the data sheet for the respective Siegling Extremultus Flat Belt.</p> |

# 9.5 OPERATING FACTOR $c_2$

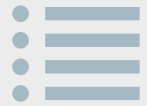

| Type of drive  | Examples of drives  | Operation factor $c_2$ |
|--|---|------------------------|
| Consistent operation<br>Small masses to be accelerated<br>Load-free acceleration                                   | Generators with low capacity<br>Centrifugal pumps<br>Automatic lathes<br>Lightweight textile machinery  | 1.0                    |
| Almost consistent operation<br>Medium-sized masses to be accelerated<br>Usually load-free acceleration             | Small fans up to 8 kW<br>Tool machines<br>Rotary piston compressor<br>Wood processing machinery<br>Light and medium-weight<br>Generators<br>Grain mills<br>Multi-stage gearbox<br>Carding machines<br>Extruders<br>Stone frame saws<br>Screw-type compressors   | 1.2                    |
| Irregular operation<br>Medium-sized masses to be accelerated<br>Sudden force                                       | Piston pumps, compressors<br>Degree of uniformity > 1:80<br>Centrifuges<br>Large pressure pumps<br>Fans<br>Kneading machines<br>Beaters<br>Crushing mills<br>Pebble mills<br>Tube mills<br>Looms<br>Agitators<br>Cutting machines wood industry<br>Vehicle body presses<br>Conical belts paper industry | 1.35                   |
| Irregular operation<br>Large-sized masses to be accelerated<br>Substantial sudden force<br>Acceleration under load | Piston pumps, compressors<br>Degree of uniformity > 1:80<br>Wood frame saws<br>Jolters<br>Excavator drives<br>Edge runners<br>Rolling machines<br>Brick presses<br>Forging presses<br>Sheers<br>Punch presses<br>Roller mills<br>Stone crushers<br>Flakers  | 1.7                    |

Depending on drive's torque, the following minimum parameters during operation must be kept to:

| Drive   | Minimum value $c_2$ |
|---|---------------------|
| Speed-controlled electric motors (e.g. frequency converters)  | 1.0                 |
| Electrical motors with Y-delta connection<br>Electrical motors with mechanical, or hydrodynamic clutch<br>Pole-changing electrical motors<br>Combustion engines<br>Water turbines | 1.3                 |
| Electrical motors, directly switched on without centrifugal clutch  | 1.7                 |

# 9.6 BASIC ELONGATION AT FITTING $c_4$



## Polyamide line – Sheet

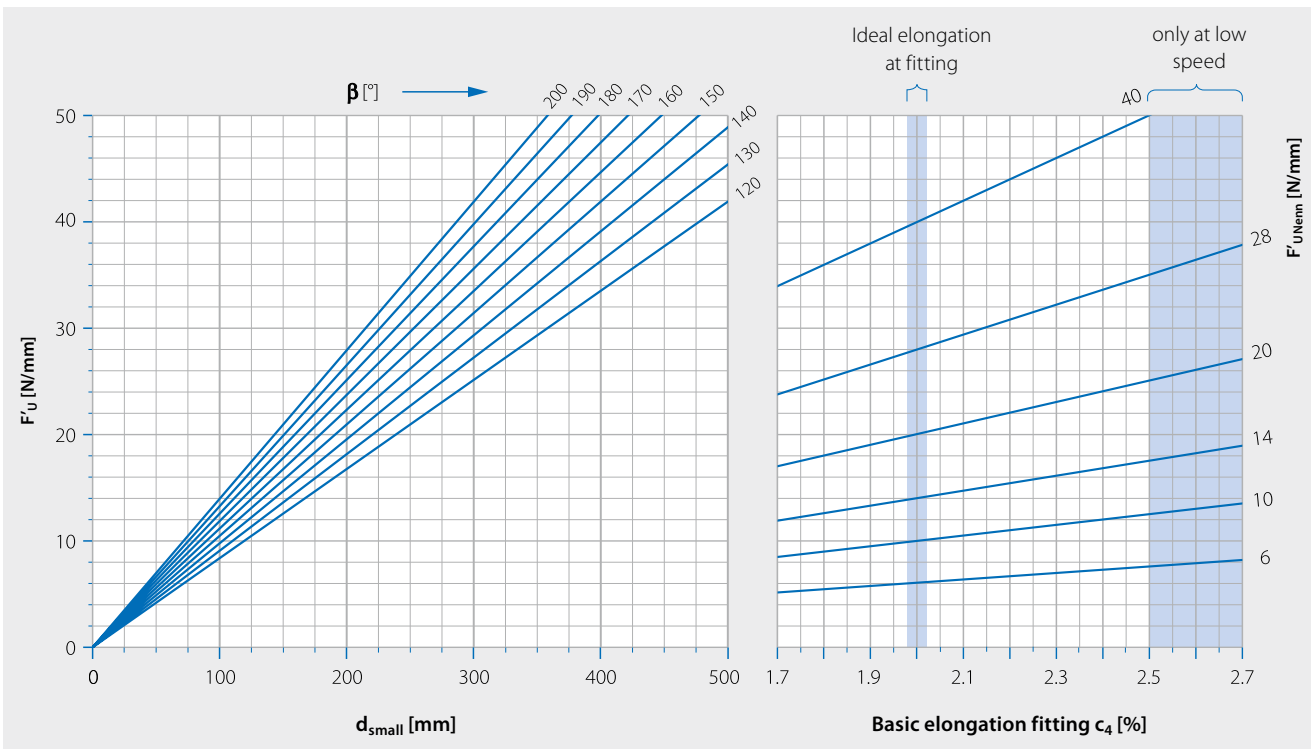
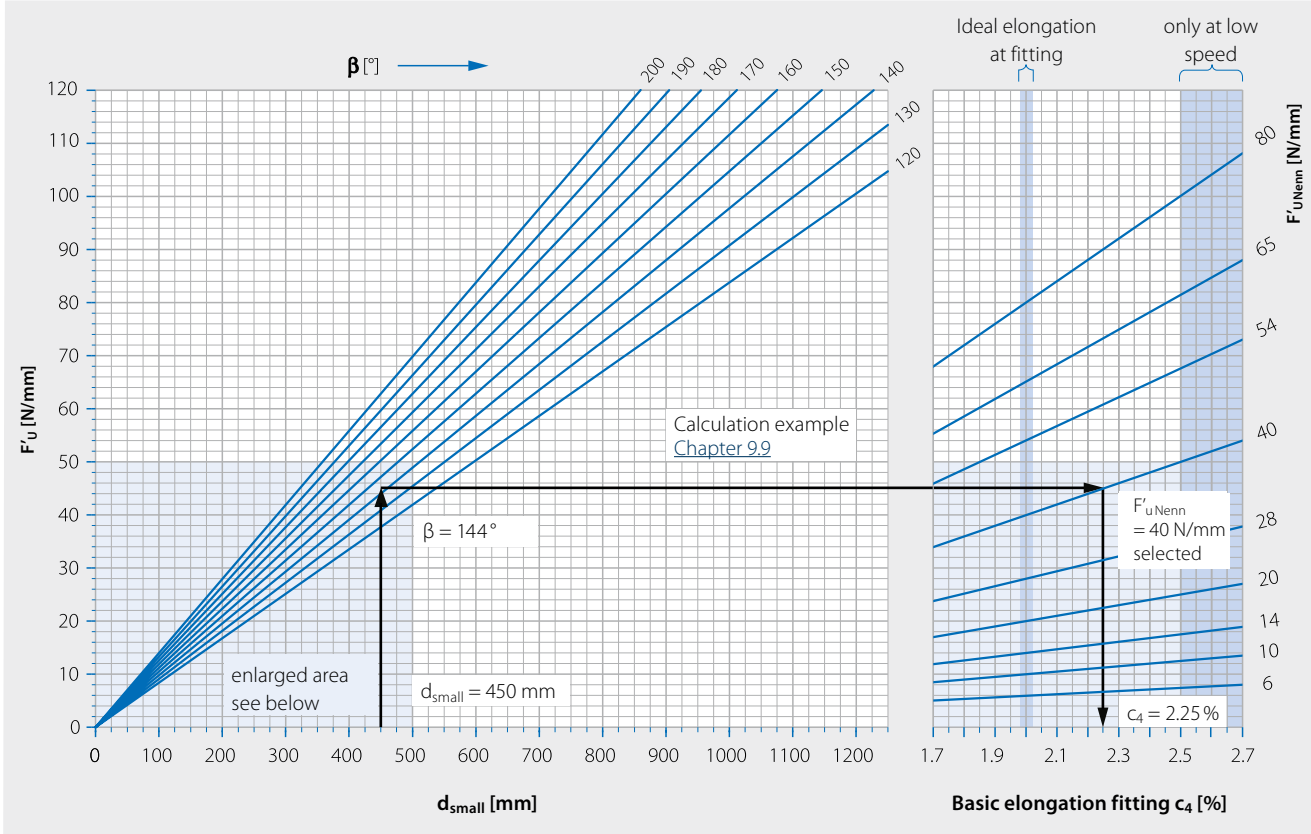

# 9.6 BASIC ELONGATION AT FITTING $c_4$

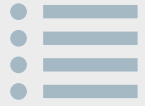

## Polyester line – Fabric

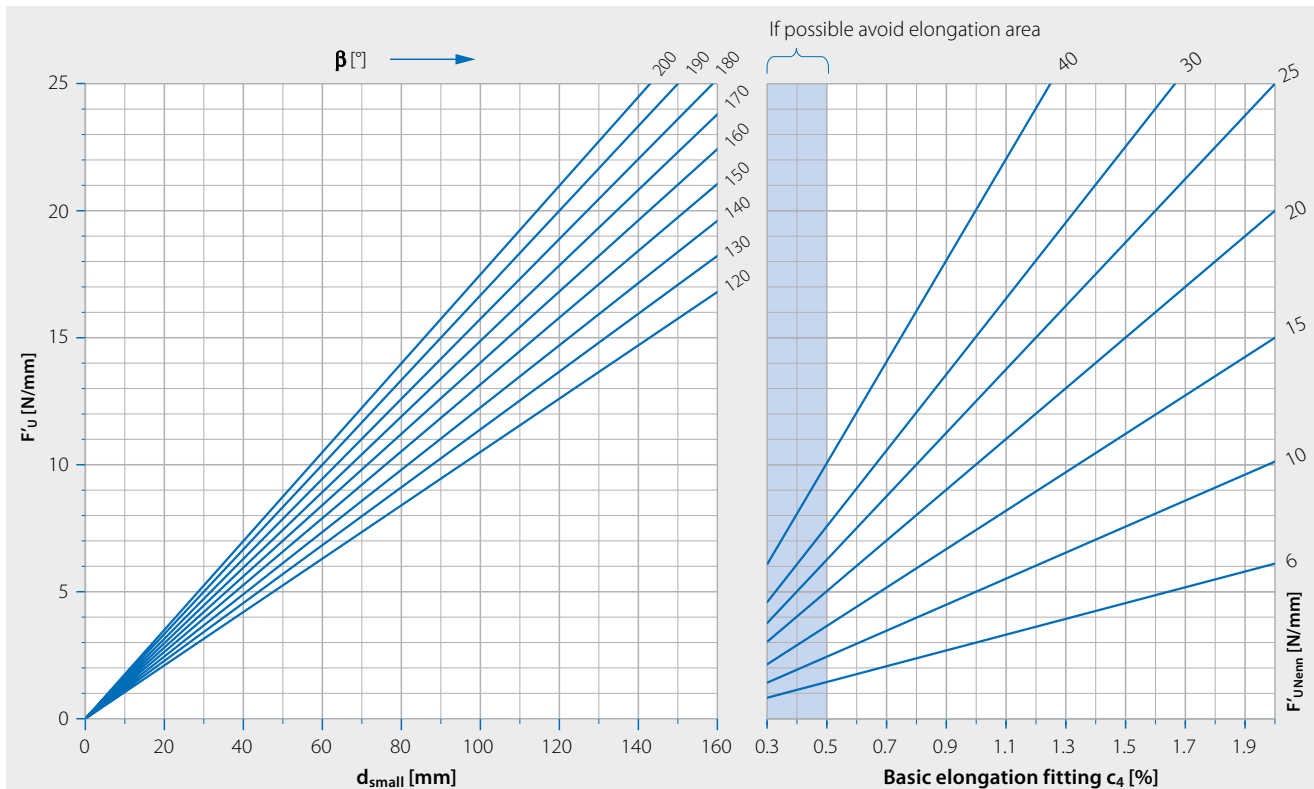
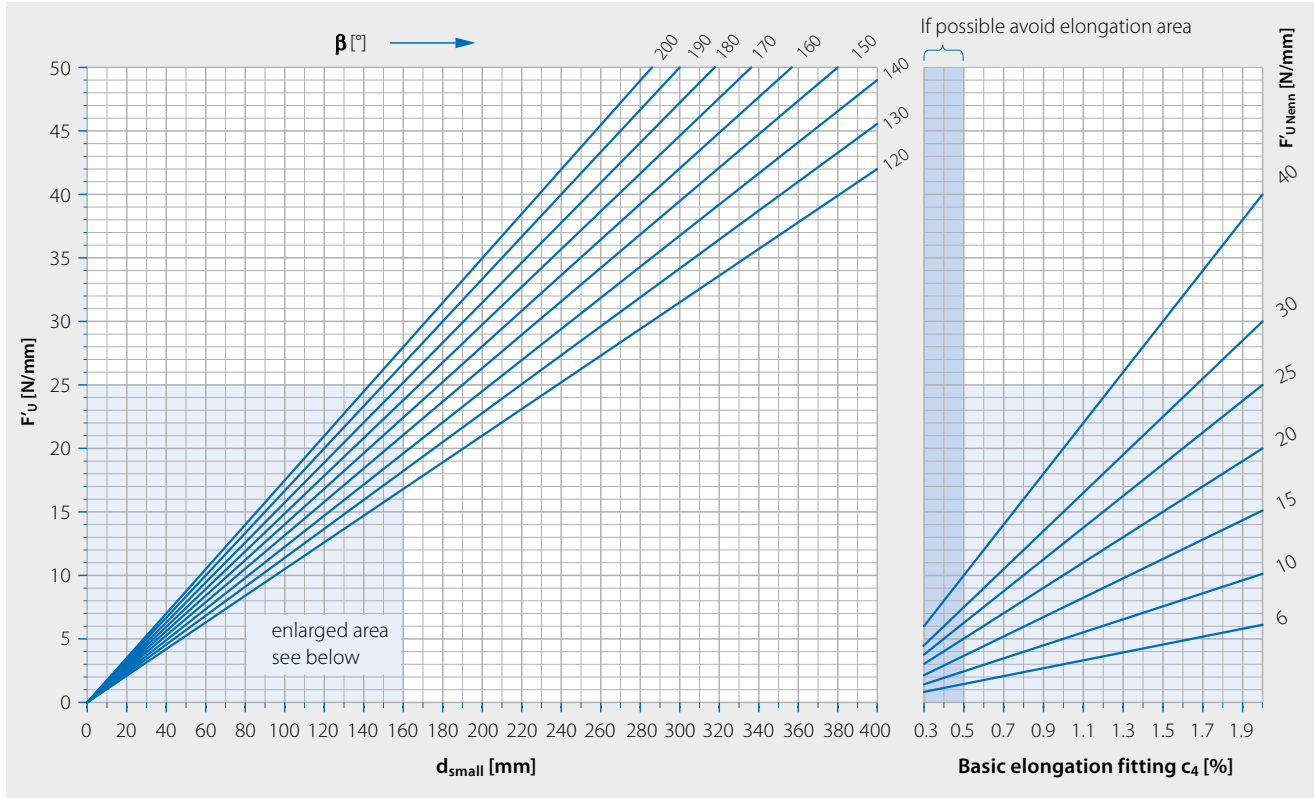

Info about the Polyester line: where belts have U coating, due to the low structural strength of the Polyurethane, the transferrable effective pull must be reduced by 1/3. Depending on the type, basic elongation at fitting of > 2.0% is possible, but Forbo Movement Systems should be consulted.



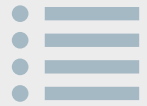

## Polyester line – Cord

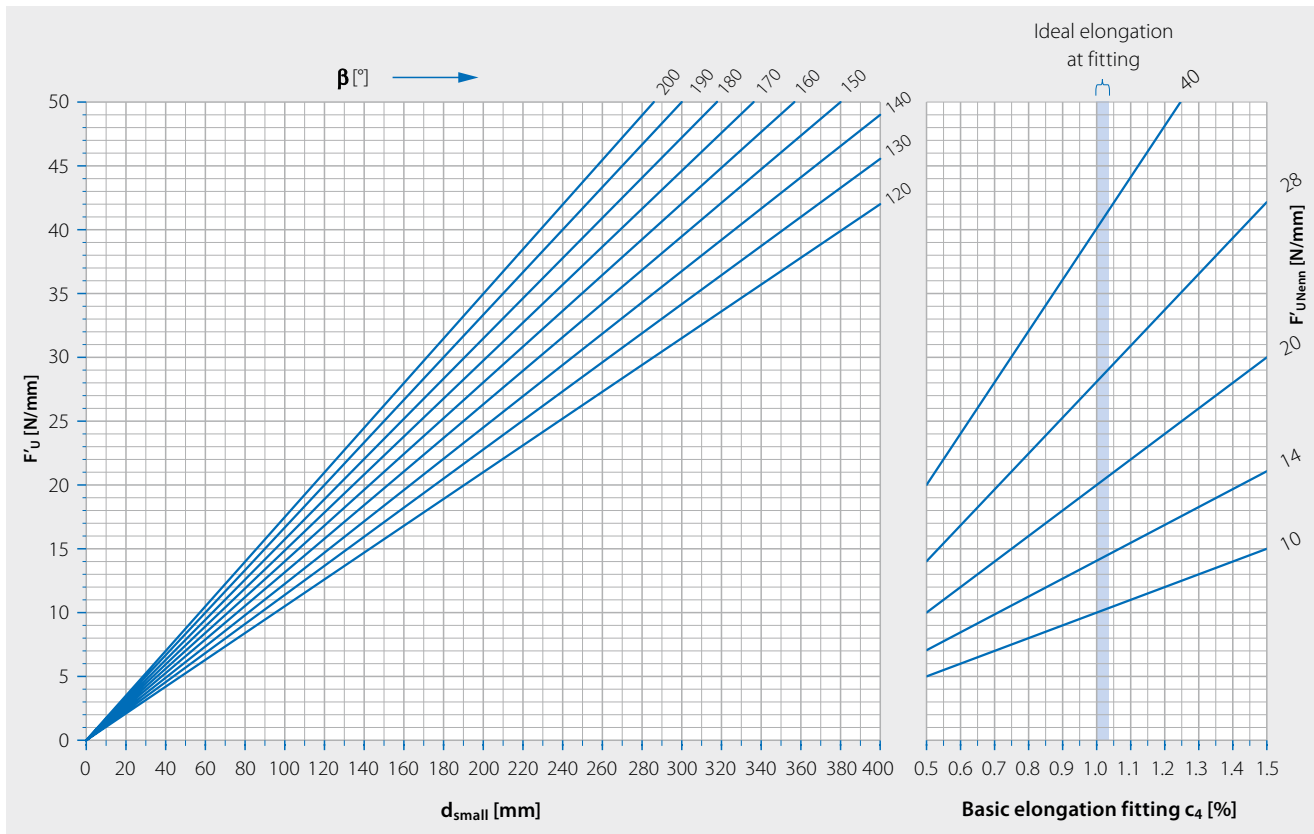

Info about the Polyester line: where belts have U coating, due to the low structural strength of the Polyurethane, the transferrable effective pull must be reduced by 1/3. The belts can be subjected to extreme stress and when they have a rubber friction layer, they may fall below the diameter thresholds shown in the diagram. Where heavy-duty drives are concerned, we recommend you talk to Forbo Movement Systems application engineers.

# 9.6 BASIC ELONGATION AT FITTING $c_4$

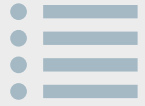

## Aramide line – Fabric

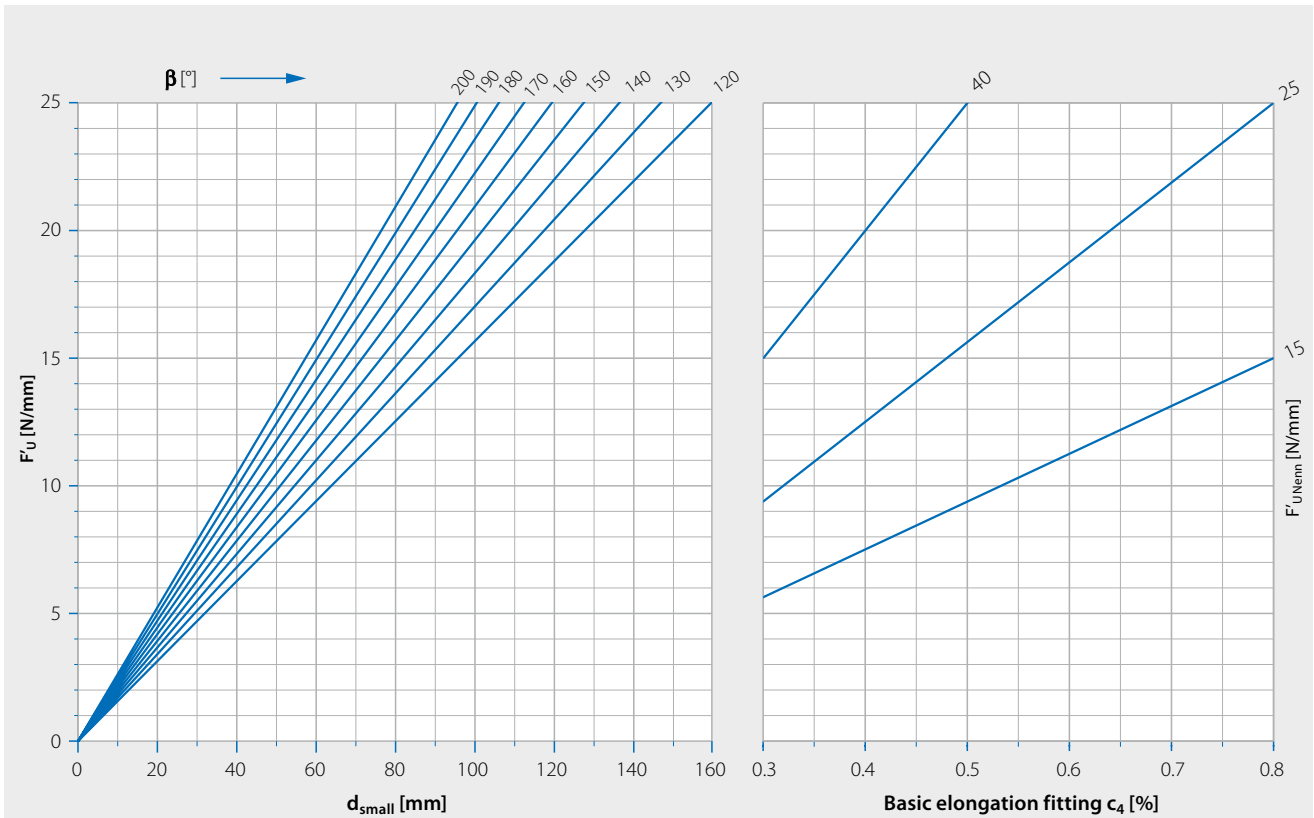
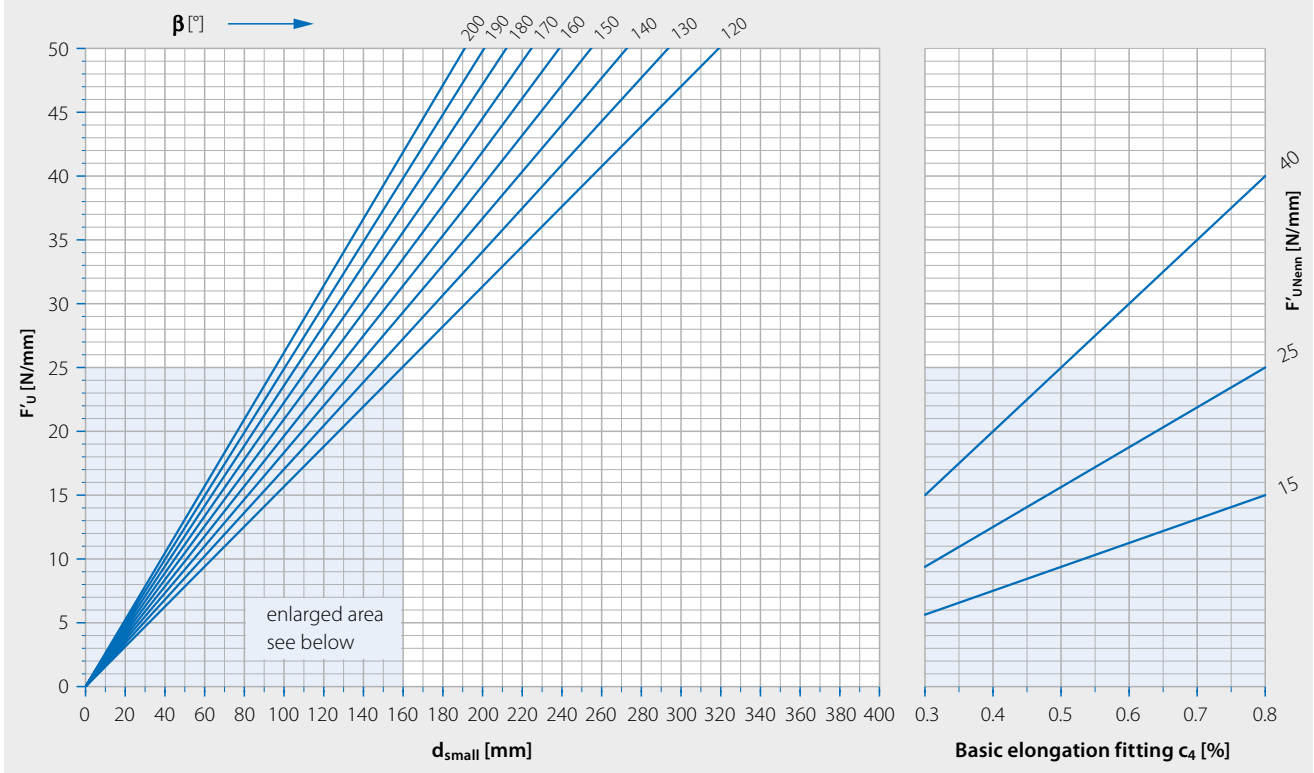

Info about the Aramide line: where belts have U coating, due to the low structural strength of the Polyurethane, the transferrable effective pull must be reduced by 1/3. Depending on the type, basic elongation at fitting of  $> 0.8\%$  is possible, but application engineers at Forbo Movement Systems should be consulted.

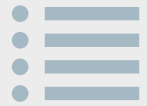

## Aramide line – Cord

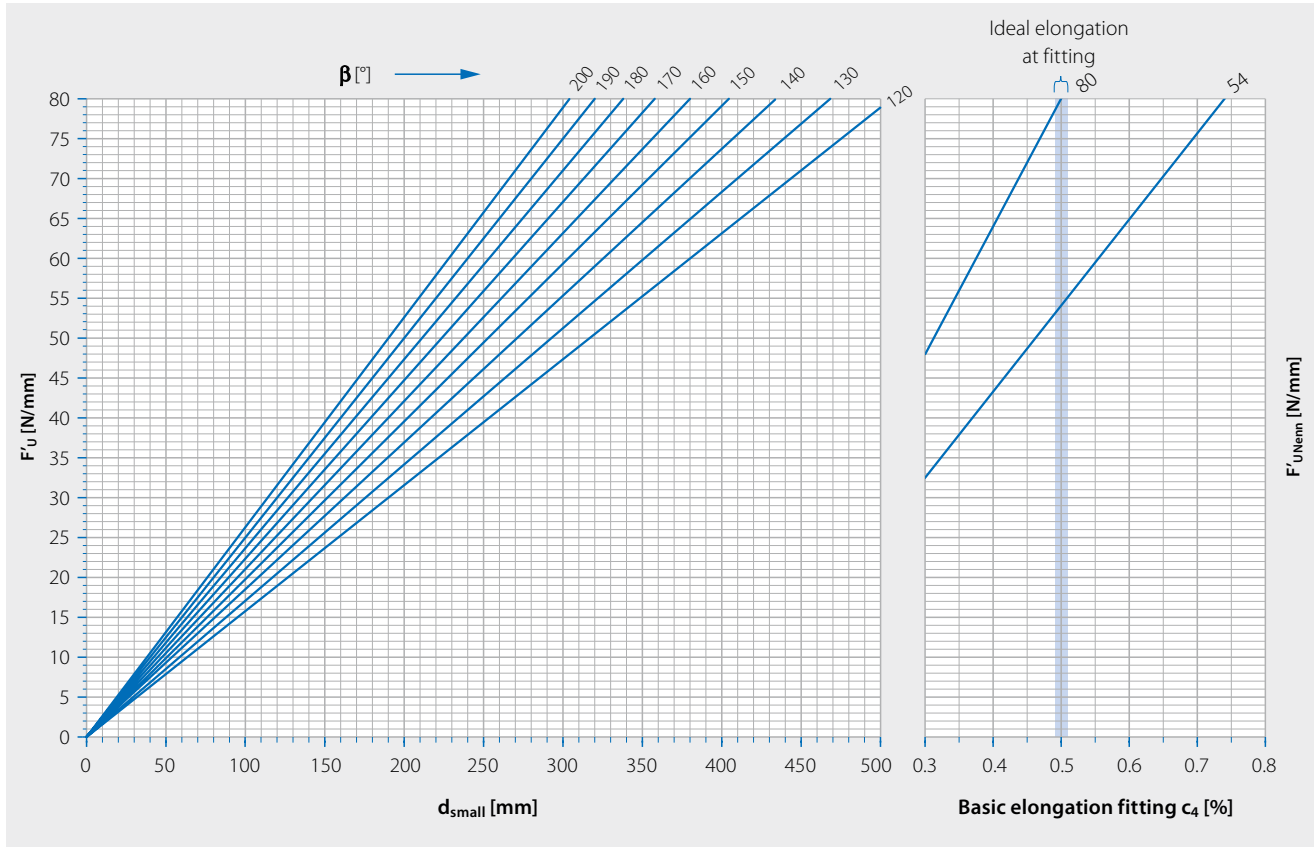

Info about the endless Aramide line: The belts can be subjected to extreme stress and when they have a rubber friction layer, they may fall below the diameter thresholds shown in the diagram. Under certain conditions, the transferable effective pull can also be increased far above the nominal effective pull. Where heavy-duty drives are concerned, we recommend you talk to Forbo Movement Systems application engineers.

# 9.7 ELONGATION ALLOWANCE FOR CENTRIFUGAL FORCE $C_5$

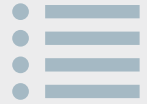

## Polyester line

| $F'_{UNenn}$ | v [m/s] |      |     |
|--------------|---------|------|-----|
|              | 30      | 40   | 50  |
| 6            | 0.1     | 0.15 | 0.2 |
| 10           | 0.1     | 0.15 | 0.2 |
| 15           | 0.1     | 0.15 | 0.2 |
| 20           | 0.1     | 0.15 | 0.2 |
| 25           | 0.1     | 0.15 | 0.2 |
| 30           | 0.1     | 0.15 | 0.2 |
| 40           | 0.1     | 0.15 | 0.2 |

**Tension member design: Fabric;**  
**coatings: all**

In the polyester line, the elongation at fitting  $\epsilon$  may not exceed 2.1 %.

| $F'_{UNenn}$ | v [m/s] |     |     |
|--------------|---------|-----|-----|
|              | 40      | 50  | 60  |
| 10           | 0.1     | 0.2 | 0.3 |
| 14           | 0.1     | 0.2 | 0.3 |
| 20           | 0.1     | 0.2 | 0.3 |
| 28           | 0.1     | 0.2 | 0.3 |
| 40           | 0.1     | 0.2 | 0.3 |

**Tension member design: Cord;**  
**coatings: GT, GG, UU**

For endless belts in the polyester line, the elongation at fitting  $\epsilon$  may not exceed 1.5 %.

For belt speeds over 60 m/s, we encourage you to contact Forbo Movement Systems application support.

| $F'_{UNenn}$ | v [m/s] |      |     |      |
|--------------|---------|------|-----|------|
|              | 30      | 40   | 50  | 60   |
| 10           | 0.1     | 0.15 | 0.2 | 0.25 |
| 14           | 0.1     | 0.15 | 0.2 | 0.25 |
| 20           | 0.1     | 0.15 | 0.2 | 0.25 |
| 28           | 0.1     | 0.15 | 0.2 | 0.25 |
| 40           | 0.1     | 0.15 | 0.2 | 0.25 |

**Tension member design: Cord;**  
**coatings: LT, LL**

For endless belts in the polyester line, the elongation at fitting  $\epsilon$  may not exceed 1.5 %.

For belt speeds over 60 m/s, we encourage you to contact Forbo Movement Systems application support.



## Aramide line

| F' <sub>UNenn</sub> | v [m/s] |      |
|---------------------|---------|------|
|                     | 40      | 50   |
| 15                  | 0.05    | 0.05 |
| 25                  | 0.05    | 0.05 |
| 40                  | 0.05    | 0.05 |

**Tension member design: Fabric;**  
**coatings: all**

In the aramide line, the elongation at fitting  $\epsilon$  may not exceed 1 %.

| F' <sub>UNenn</sub> | v [m/s] |      |     |
|---------------------|---------|------|-----|
|                     | 40      | 50   | 60  |
| 54                  | 0.05    | 0.05 | 0.1 |
| 80                  | 0.05    | 0.05 | 0.1 |

**Tension member design: Cord;**  
**coatings: GT, GG, LT**

For endless belts in the aramide line, the elongation at fitting  $\epsilon$  may not exceed 1 %.

For belt speeds over 60 m/s, we encourage you to contact Forbo Movement Systems application support.

## Polyamide line

| F' <sub>UNenn</sub> | v [m/s] |     |     |     |     |     |
|---------------------|---------|-----|-----|-----|-----|-----|
|                     | 20      | 30  | 40  | 50  | 60  | 70  |
| 6                   | 0.2     | 0.3 | 0.7 | 1.0 | *   | *   |
| 10                  | 0.2     | 0.3 | 0.6 | 0.9 | *   | *   |
| 14                  | 0.1     | 0.3 | 0.5 | 0.8 | 1.0 | *   |
| 20                  | 0.1     | 0.3 | 0.4 | 0.7 | 1.0 | *   |
| 28                  | 0.1     | 0.2 | 0.4 | 0.6 | 0.8 | *   |
| 40                  | 0.1     | 0.2 | 0.3 | 0.5 | 0.7 | 1.0 |
| 54                  | 0.1     | 0.2 | 0.3 | 0.5 | 0.7 | 0.9 |
| 80                  | 0.1     | 0.2 | 0.3 | 0.4 | 0.6 | 0.8 |

**Tension member design: Sheet;**  
**coatings: GT**

For belts in the polyamide line, the elongation at fitting  $\epsilon$  may not exceed 3 %.

| F' <sub>UNenn</sub> | v [m/s] |     |     |     |     |     |
|---------------------|---------|-----|-----|-----|-----|-----|
|                     | 20      | 30  | 40  | 50  | 60  | 70  |
| 6                   | 0.3     | 0.6 | 1.0 | *   | *   | *   |
| 10                  | 0.2     | 0.5 | 0.8 | *   | *   | *   |
| 14                  | 0.2     | 0.4 | 0.6 | 1.0 | *   | *   |
| 20                  | 0.1     | 0.3 | 0.5 | 0.9 | 1.0 | *   |
| 28                  | 0.1     | 0.2 | 0.4 | 0.7 | 0.9 | *   |
| 40                  | 0.1     | 0.2 | 0.3 | 0.6 | 0.8 | 1.0 |
| 54                  | 0.1     | 0.2 | 0.3 | 0.5 | 0.8 | 1.0 |
| 65                  | 0.1     | 0.2 | 0.3 | 0.5 | 0.7 | 0.9 |
| 80                  | 0.1     | 0.2 | 0.3 | 0.5 | 0.7 | 0.9 |

**Tension member design: Sheet;**  
**coatings: LT**

For belts in the polyamide line, the elongation at fitting  $\epsilon$  may not exceed 3 %.

\* For belt speeds of 70 m/s and higher, we recommend you always ask Forbo Movement Systems to support you in selecting the right Siegling Extremultus Flat Belt type.

# 9.8 VIBRATION CALCULATION

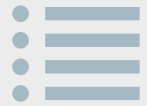

A flat belt drive is a dynamic system which can vibrate. Depending on the application, the system is periodically excited by the driving and/or driven machine, resulting in transversal and/or longitudinal vibrations.

To avoid unwanted effects such as shortened service life, the periodic exciter frequency may not be near the eigenfrequency of the flat belt. This so-called resonance is a relatively rare occurrence thanks to the outstanding damping properties and resulting low eigenfrequency of Siegling Extremultus flat belts.

However, we do recommend that vibration calculations for longitudinal vibrations be carried out by Forbo Movement Systems, in particular for piston compressors, water turbines (Kaplan, Francis), multiple blade frame saws or similar components.

## Bending frequency

The maximum permissible bending frequency depends on the design of the flat belt. When the bending frequency is too high, the service life of a flat belt can be shortened and the noise generated by the endless splice running up onto the pulley can be considerable. In the event of high bending frequencies, wedge splices in the polyamide line should always be 60°.

Forbo Movement Systems should always be consulted in the event of bending frequencies above 30 Hz.

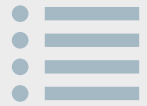

## Longitudinal eigenfrequency

The longitudinal eigenfrequency of a flat belt depends on the spring rate of the flat belt  $c_R$  and on the mass moments of inertia ( $J_1$ ) of the driving and driven pulley ( $J_2$ ).

In terms of measurement, it is very difficult to show longitudinal vibrations. Signs of longitudinal vibration include excessive wear of the underside of the flat belt, polished pulley surfaces and fine red powder. Existing longitudinal vibrations can only be eliminated by using a flat belt with a different tension member material.

Resonance is avoided when the exciter frequency  $f_{err}$  differs from the eigenfrequency of the system by at least 30%.

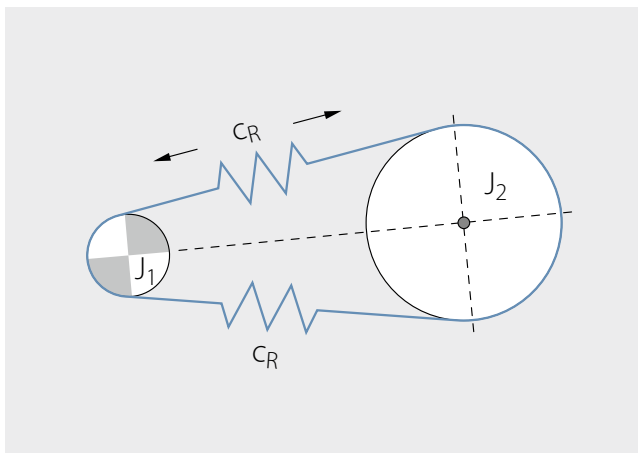

## Transversal eigenfrequency

The transversal eigenfrequency of a flat belt depends on the freely-vibrating belt length  $l_s$ , the force in the belt strand (tight side of the belt  $F_1$ , slack side of the belt  $F_2$ ) and the weight per metre of the flat belt  $m'_R$ .

That means that the eigenfrequency on both the tight side and the slack side of the belt are to be considered to obtain a complete vibration analysis.

Transversal vibrations are obvious – the flat belt flaps excessively. This can be avoided by integrating a tangential roller (steady roller), or by changing the shaft distance or belt tension.

Resonance is avoided if there is a difference of at least 20% between the exciter frequency  $f_{err}$  and the flat belt's eigenfrequency (on the tight side of the belt  $f_1$  and the slack side of the belt  $f_2$ ).

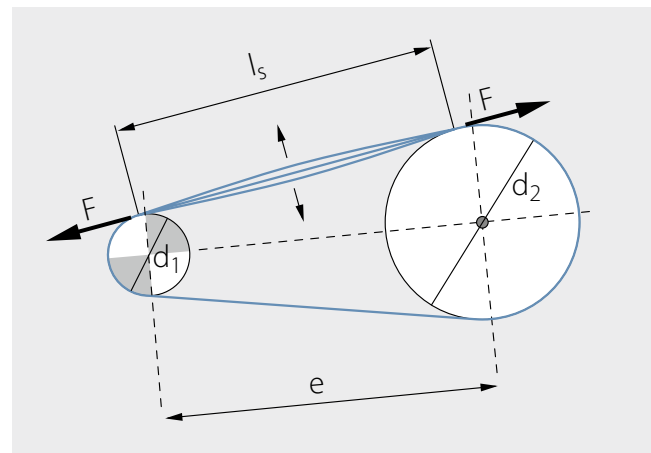

# 9.9 CALCULATION EXAMPLE

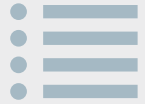

Motor capacity  $P = 280 \text{ kW}$   
 Diameter of drive pulley  $d_1 = 450 \text{ mm}$   
 Motor speed  $n_1 = 1490 \text{ 1/min}$   
 Center distance  $e = 2500 \text{ mm}$   
 Diameter of driven pulley  $d_2 = 2000 \text{ mm}$   
 Speed of driven pulley  $n_2 = 335 \text{ 1/min}$   
 Ambient conditions are dusty, free of oil, normal temperature

**Required: Power Transmission Belt for electrical drive in a gang saw**

|   |  |
|---|--|
| <p><b>1</b> Arc of contact <math>\beta_1</math> and <math>\beta_2</math></p>  | $\beta_1 = 2 \cdot \arccos \left( \frac{(2000 \text{ mm} - 450 \text{ mm})}{2 \cdot 2500 \text{ mm}} \right) = 143.9^\circ$ $\beta_2 = 2 \cdot \arccos \left( \frac{(450 \text{ mm} - 2000 \text{ mm})}{2 \cdot 2500 \text{ mm}} \right) = 216.1^\circ$  |
| <p><b>2</b> Belt speed <math>v</math><br/>Effective pull to be transmitted <math>F_U</math></p>   | $v = \pi \cdot \frac{450 \text{ mm}}{1000 \text{ mm/m}} \cdot \frac{1490 \text{ 1/min}}{60 \text{ s/min}} = 35.1 \text{ m/s}$ $F_U = \frac{280 \text{ kW} \cdot 1000 \text{ W/kW}}{35.1 \text{ m/s}} = 7976 \text{ N}$   |
| <p><b>3</b> Reference force <math>F_B</math><br/>operating factor <math>c_2</math></p>  | $F_B = 7976 \text{ N} \cdot 1.7 = 13559 \text{ N}$ <p>Read <math>c_2 = 1.7</math> off the "Operating factor" table (<a href="#">see Chapter 9.5</a>)</p>   |
| <p><b>4</b> Width-based Effective pull <math>F'_U</math><br/>width-based Nominal effective pull <math>F'_{UNenn}</math><br/>Basic elongation at fitting <math>c_4</math><br/>Flat belt preselection</p> | <p>On the basis of the ambient conditions, a Siegling Extremultus flat belt with polyamide sheet and rubber coating can be used. The diagram for the polyamide line is evaluated:</p> <div style="text-align: center;"> <p style="text-align: center;"><math>d_{\text{small}} = 450 \text{ mm} = d_1</math></p> </div> <p>GT 40P black (850049) is preselected (<a href="#">see Chapter 4</a>) based on the width-based nominal effective pull of <math>F'_{UNenn} = 40 \text{ N/mm}</math>.</p>                               |
| <p><b>5</b> Width of the flat belt <math>b_0</math></p>   | $b_0 = \frac{13559 \text{ N}}{45 \text{ N/mm}} = 301 \text{ mm} \quad b_0 = 320 \text{ mm is selected}$  |
| <p><b>6</b> Arc length at the driving pulley <math>l_1</math> and driven pulley <math>l_2</math><br/>Freely vibrating length <math>l_s</math><br/>Geometrical belt length <math>l</math></p>            | $l_1 = \pi \cdot \frac{450 \text{ mm}}{2} \cdot \frac{143.9^\circ}{180^\circ} = 565 \text{ mm}$ $l_2 = \pi \cdot \frac{2000 \text{ mm}}{2} \cdot \frac{216^\circ}{180^\circ} = 3772 \text{ mm}$ $l_s = \sqrt{(2500 \text{ mm})^2 - \frac{(2000 \text{ mm} - 450 \text{ mm})^2}{4}} = 2377 \text{ mm}$ $l = 565 \text{ mm} + 3772 \text{ mm} + 2 \cdot 2377 \text{ mm} = 9091 \text{ mm}$ <p>Note: The length of the flat belt to order depends on the type of tensioning (<a href="#">see Chapter 5.2 and Chapter 6.3</a>)</p> |



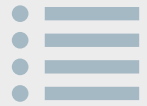

|          |   |   |
|----------|---|---|
| <b>7</b> | Elongation at fitting $\epsilon$<br>Elongation allowance for centrifugal force $c_5$  | $\epsilon = 2.25\% + 0.25\% = 2.5\%$<br>$c_5 = 0.25\%$ read from the table for polyamide GT line ( <a href="#">Chapter 9.7</a> )  |
| <b>8</b> | Shaft load $F_W$<br>At a standstill $F_{Ws}$<br>While operating $F_{Wd}$<br>Initial value of shaft load $F_{Winitial}$<br>Running in ratio $c_{initial}$  | $F'_W = 40 \text{ N/mm}$ for GT 40P black (850049) read off data sheet ( <a href="#">see Chapter 2.5</a> ).<br>$F_{Ws} = 2.5\% \cdot 40 \text{ N/(mm} \cdot \%) \cdot 320 \text{ mm} = 32000 \text{ N}$<br>$F_{Wd} = 2.25\% \cdot 40 \text{ N/(mm} \cdot \%) \cdot 320 \text{ mm} = 28800 \text{ N}$<br>$F_{Winitial} = 2.2 \cdot 2.5\% \cdot 40 \text{ N/(mm} \cdot \%) \cdot 320 \text{ mm} = 70400 \text{ N}$<br>$c_{initial} = 2.2$ read from the table running-in ratio in <a href="#">Chapter 6.3</a>   |
| <b>9</b> | Vibration calculation<br><br>Vibration calculation $f_{err}$<br><br>Weight per metre of the flat belt $m'_R$<br><br>Belt force on tight side of the belt $F_1$<br>Belt force on slack side of the belt $F_2$<br><br>Transversal eigenfrequency:<br>on the tight side of the belt $f_1$<br><br>on the slack side of the belt $f_2$ | Like all crank drives, a gang saw transmits power unevenly. For every rotation of the drive pulley, it carries out 2 working strokes (= $z_{err}$ ).<br>$f_{err} = \frac{335 \text{ 1/min}}{60 \text{ s/min}} \cdot 2 = 11.2 \text{ Hz}$ Use the speed of the driven pulley for n.<br>$m'_R = 4 \text{ kg/m}^2 \cdot \frac{320 \text{ mm}}{1000 \text{ mm/m}} = 1.28 \text{ kg/m}$ Read off $m'$ from the data sheet for the respective Siegling Extremultus flat belt.<br>$F_1 = \frac{32000 \text{ N} + 7976 \text{ N}}{2} = 19988 \text{ N}$<br>$F_2 = \frac{32000 \text{ N} - 7976 \text{ N}}{2} = 12012 \text{ N}$<br>$f_1 = \frac{1000 \text{ mm/m}}{2377 \text{ mm}} \sqrt{\frac{19988 \text{ N}}{4 \cdot 1.28 \text{ kg/m}}} = 26.3 \text{ Hz}$<br>$f_2 = \frac{1000 \text{ mm/m}}{2377 \text{ mm}} \sqrt{\frac{12012 \text{ N}}{4 \cdot 1.28 \text{ kg/m}}} = 20.4 \text{ Hz}$<br><b>The eigenfrequencies of the tight and slack side of the belt both differ by more than 20% of the exciter frequency. There is therefore no risk of transversal vibrations (flapping) of the flat belt.</b> |

**Solution:** GT 40 P black (850049) is suitable for this application





# 10 CALCULATION OF LIVE ROLLER BELTS

10.1 [General information](#)

10.2 [Terminology](#)

10.3 [Calculation method](#)

# 10.1 GENERAL INFORMATION

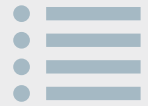

We always recommend designing live roller drive belts using our calculation software B\_Rex (see Chapter 4.5). The software features prefabricated models for classic roller conveyors with rear or head drives (see image).

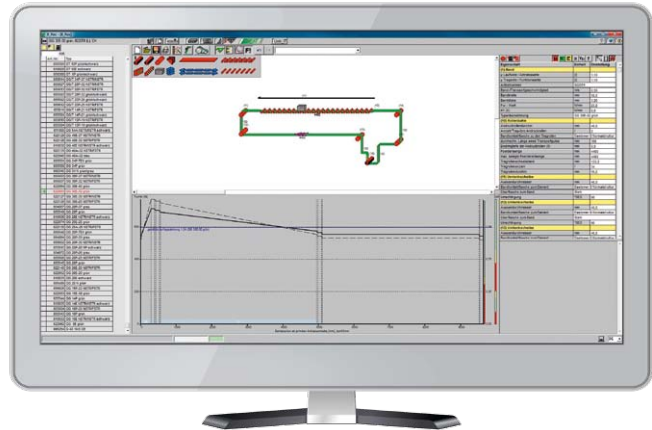

This chapter also contains a description of how to calculate the design of live roller drive belts by hand.

To properly design a live roller belt, regardless of whether you use the calculation software B\_Rex or do the calculation by hand, a series of data about the machine and how it operates is required. Ideally this information is provided by the manufacturer and/or operator of the machine.

The information includes geometric data for the machinery (including the number and diameter of the conveying and pressure rollers, diameter of drive and drum pulleys, conveying length, etc.) as well as information about loading and possible accumulation. Further, it often includes requirements regarding the belt thickness  $s$ , belt width  $b_0$  and the max. loading of the live roller from an existing machinery design.

A list of these basic essential machine parameters can be found in the Siegling Extremultus application checklist. Please contact your local representative for more information:

[www.forbo.com/movement](http://www.forbo.com/movement) > [Contact](#)

Live roller belts should be designed based on these machine parameters. The design comprises the following calculation steps:

- Calculation of the effective pull
- Calculation of the belt width and elongation at fitting
- Calculation of transmission of power at the drive pulley
- Calculation of the arc of contact on the conveying rollers
- Calculation of the engagement depth

# 10.2 TERMINOLOGY

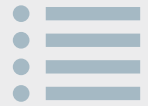

| Abbreviation         | Unit     | Designation   |
|----------------------|----------|---|
| $b_0$                | mm       | Width of the flat belt  |
| $b_{0,actual}$       | mm       | Selected width of the flat belt                                     |
| $b_{0,min}$          | mm       | Minimum required width of the flat belt                             |
| $d_{CR}$             | mm       | Diameter of the conveying rollers                                   |
| $d_{drive}$          | mm       | Diameter of the drive pulley  |
| $e_{CR}$             | mm       | Center distance between the conveying rollers                       |
| $F'_{U,Nenn}$        | N/mm     | Width-based nominal effective pull at nominal elongation at fitting |
| $F'_{U,Nenn,min}$    | N/mm     | Minimum required nominal effective pull (per mm of belt width)      |
| $F_{U,a}$            | N        | Effective pull resulting from acceleration                          |
| $F_{U,accumulation}$ | N        | Effective pull resulting from accumulation                          |
| $F_{U,bend}$         | N        | Effective pull resulting from bending                               |
| $F_{U,CR}$           | N        | Effective pull on one conveyor roller                               |
| $F_{U,incline}$      | N        | Effective pull resulting from incline                               |
| $F_{U,J}$            | N        | Effective pull resulting from inertia                               |
| $F_{U,load}$         | N        | Effective pull resulting from load                                  |
| $F_{U,max}$          | N        | Maximum transmissible effective pull                                |
| $F_{U,req}$          | N        | Required total effective pull                                       |
| $g$                  | $m/s^2$  | Acceleration due to gravity   |
| $l_{convey}$         | m        | Conveying length  |
| $m'_L$               | kg/m     | Line load   |
| $m_{CR}$             | kg       | Mass of the conveying rollers                                       |
| $m_R$                | kg       | Mass of the flat belt   |
| $n_{CR}$             | –        | Number of conveying rollers   |
| $s$                  | mm       | Thickness of the flat belt  |
| $x$                  | mm       | Infeed of the pressure roller                                       |
| $y$                  | mm       | Engagement depth of the belt into the conveying rollers             |
| $\alpha$             | °        | Arc of contact between flat belt and conveying roller               |
| $\beta_1$            | °        | Arc of contact between flat belt and drive pulley                   |
| $\epsilon$           | %        | Elongation at fitting   |
| $\epsilon_{Nenn}$    | %        | Nominal elongation at fitting                                       |
| $\mu_r$              | –        | Coefficient of friction for rolling support                         |
| $\rho_{max}$         | $N/mm^2$ | Transmission capacity   |

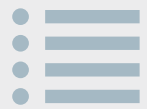

# 10.3. CALCULATION METHOD

## Calculation of the effective pull

The effective pull required to safely operate the respective live roller is made up of several elements. They include:

- Effective pull resulting from load ( $F_{U,load}$ )
- Effective pull resulting from incline ( $F_{U,incline}$ )
- Effective pull resulting from accumulation ( $F_{U,accumulation}$ )
- Effective pull resulting from inertia ( $F_{U,i}$ )
- Effective pull resulting from bending ( $F_{U,bend}$ )
- Effective pull resulting from acceleration ( $F_{U,a}$ )

The required total effective pull  $F_{U,req}$  is the sum of the effective pull elements.

$$F_{U,req} = F_{U,load} + F_{U,incline} + F_{U,accumulation} + F_{U,i} + F_{U,bend} + F_{U,a}$$

Depending on the topology and geometry of the machinery as well as the degree of contact between the conveying rollers and the power transmission belt, the elements of effective pull can vary greatly from machine to machine.

However, in most cases there is no comprehensive data available to calculate all of the effective pull elements. This means that only the effective pull resulting from load can be calculated using the following formula:

$$F_{U,load} = (l_{convey} \cdot m'_L + m_R + m_{CR}) \cdot \mu_r \cdot g$$

The friction coefficient for rolling support (running over a roller) can be assumed to be  $\mu_r = 0.033$ .

To estimate the required total effective pull  $F_{U,req}$  in a horizontal conveyor system, the effective pull element for load  $F_{U,load}$  is multiplied by an adjustment factor of 3.

$$F_{U,req} \approx 3 \cdot F_{U,load}$$

## Calculation of the belt width and elongation at fitting

Requirements for maximum belt width  $b_0$  are often set out at the time of design, in other words by the machine manufacturer. The following equation is then used to calculate the minimum nominal effective pull  $F'_{UNenn,min}$  required by the belt for this application.

$$F'_{UNenn,min} = \frac{F_{U,req}}{b_0}$$

Now select a belt from the B\_Rex belt database or from the Extremultus Product Finder whose nominal effective pull  $F'_{UNenn}$  is greater than the minimum required nominal effective pull  $F'_{UNenn,min}$ .

$$F'_{UNenn} > F'_{UNenn,min}$$

The nominal effective pull of each product is listed in the respective data sheet ([see Chapter 2.5](#)).

If there is no belt with an appropriately high nominal effective pull and/or the width can be varied, the above formula can be transposed using  $b_0$  so that the minimum belt width  $b_{0,min}$  is calculated from the quotient of the required effective pull and the nominal effective pull of a selected belt (selected from B\_Rex or Extremultus Product Finder > application group: live roller belt):

$$b_{0,min} = \frac{F_{U,req}}{F'_{UNenn}}$$

For good measure you should then select an actual belt width  $b_{0,actual}$  that is greater than the calculated minimum belt width.

$$b_{0,actual} > b_{0,min}$$

The following formula can now be used to roughly calculate the required elongation at fitting  $\varepsilon$ :

$$\varepsilon = \frac{F_{U,req}}{\frac{F'_{UNenn}}{\varepsilon_{Nenn}} \cdot b_{0,actual}}$$

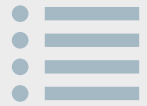

The nominal elongation at fitting  $\epsilon_{Nenn}$  is the elongation at fitting used to determine the nominal effective pull  $F'_{UNenn}$  of the selected belt. This nominal elongation at fitting is a function of the tension member material and can be assumed as follows for the respective tension member materials:

| Tension member material | $\epsilon_{Nenn}$ [%] |
|-------------------------|-----------------------|
| Aramide                 | 0.8                   |
| Polyamide               | 2.0                   |
| Polyester               | 2.0                   |

## Calculation of transmission of power at the drive pulley

The transmission of power between the flat belt and the drive pulley is a function of the so-called transmission capacity  $\rho_{max}$ . The transmission capacity  $\rho_{max}$  depends on the material and refers to the tension member material used. The  $\rho_{max}$  values for the tension member materials used by Forbo Movement Systems are listed in the following table.

| Tension member material | $\rho_{max}$ [N/mm <sup>2</sup> ] |
|-------------------------|-----------------------------------|
| Aramide                 | 0.15                              |
| Polyamide               | 0.08                              |
| Polyester               | 0.10                              |

To calculate the maximum transmissible effective pull  $F_{U,max}$  that can be transmitted from a drive pulley with the selected flat belt or tension member of the belt, the transmission capacity  $\rho_{max}$  must be multiplied by the contact surface between the belt and the drive pulley. The formula used is as follows:

$$F_{U,max} = \rho_{max} \cdot \frac{\pi \cdot \beta_1}{180^\circ} \cdot b_0 \cdot \frac{d_{drive}}{2}$$

This formula contains the variables

- Arc of contact  $\beta_1$
- Width of the flat belt  $b_0$
- Diameter of the drive pulley  $d_{drive}$

Changing these variables, in consultation with the customer, can affect the maximum transmissible effective pull  $F_{U,max}$ . To ensure safe operation, the maximum transmissible effective pull  $F_{U,max}$  must be greater than or at least equal to the required total effective pull  $F_{U,req}$ .

$$F_{U,max} \geq F_{U,req}$$

To obtain the minimum limit of one of these variables, the diameter for example, transpose the formula according to  $d_{drive}$  and use the required total effective pull  $F_{U,req}$  for the maximum transmissible effective pull  $F_{U,max}$ . This results in the following formula:

$$d_{drive} \geq 2 \cdot \frac{F_{U,req}}{\frac{\pi \cdot \beta_1}{180^\circ} \cdot b_0 \cdot \rho_{max}}$$

Using this method you obtain the minimum possible drive pulley diameter for the required total effective pull calculated.

# 10.3. CALCULATION METHOD

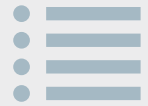

## Calculating the arc of contact on the conveying rollers

The next step is used to determine the arc of contact of the flat belt on the conveying rollers in order to guarantee that the transport task is safe and secure. To do this, estimate the effective pull  $F_{U,CR}$  that must be transmitted to a conveying roller for safe operation.

If a pressure roller is always positioned between two conveying rollers (see diagram) and we can assume that the same effective pull is transmitted to all conveying rollers, dividing the required total effective pull  $F_{U,req}$  by the number of conveying rollers  $n_{CR}$  gives the effective pull  $F_{U,CR}$  to be transmitted to a conveying roller:

$$F_{U,CR} = \frac{F_{U,req}}{n_{CR}}$$

## Calculating the engagement depth

Once the required arc of contact  $\alpha$  to the conveying rollers has been determined, the engagement depth  $y$  of the belt into the conveying rollers and thus also the infeed  $x$  of the pressure rollers can be geometrically determined (see diagram):

$$\tan(\alpha) = \frac{y}{\left(\frac{e_{CR}}{2}\right)}$$

$$y = \tan(\alpha) \cdot \left(\frac{e_{CR}}{2}\right)$$

In addition to the arc of contact on the conveying rollers, the center distance between the conveying rollers  $e_{CR}$  is also required for this calculation.

To calculate the minimum arc of contact  $\alpha$ , transpose the equation for the transmission capacity  $\rho_{max}$  to solve for the arc of contact  $\alpha$ :

$$\alpha \geq \frac{F_{U,CR}}{\frac{\pi}{180^\circ} \cdot b_0 \cdot \frac{d_{CR}}{2} \cdot \rho_{max}}$$

**Note:** If the angle  $\alpha$  selected is significantly greater, it may be necessary to recalculate the required effective pull (with a higher adjustment factor) as the effective pull portion increases as a result of the bending capacity ( $F_{U,bend}$ ).

The infeed  $x$  of the pressure rollers is calculated by subtracting the belt thickness  $s$  from the engagement depth  $y$  of the belt:

$$x = y - s$$

**Note:** When the infeed of the pressure rollers is  $x = 0$  mm, the engagement depth  $y$  is equal to the belt thickness  $s$  (see diagram).

A live roller belt can be completely designed for the respective application using this formula. However, before making a binding order we recommend having our experts check the calculation. Please contact your local representative: [www.forbo.com/movement](http://www.forbo.com/movement) > Contact



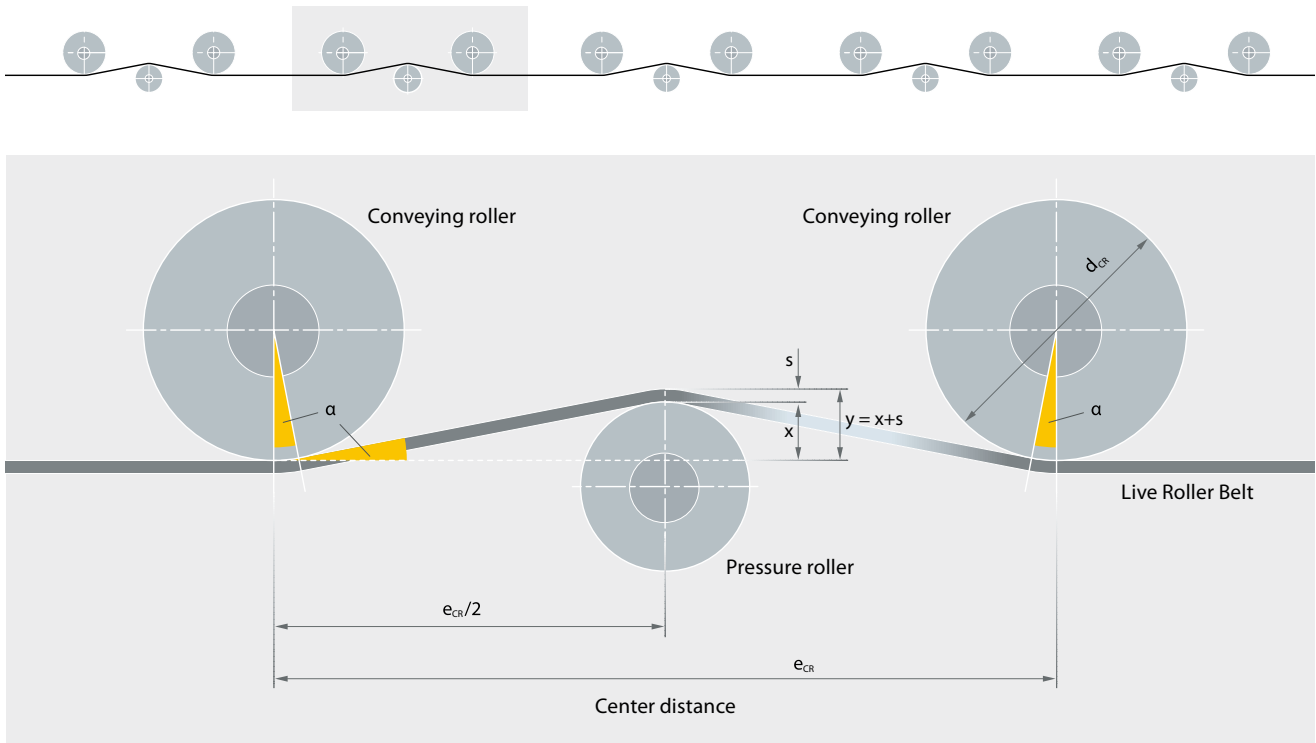

**Note:** A good start value for a live roller belt calculation is an engagement depth  $y$  equal to half of the belt thickness  $s$ .

$$y = s/2$$

$$x = y - s = s/2 - s = -s/2$$





# 11 TROUBLE-SHOOTING

11.1 [Installation](#)

11.2 [Splice opening](#)

11.3 [Noise generation](#)

11.4 [Poor belt tracking](#)

11.5 [Wear](#)

11.6 [Changes in properties](#)

# 11.1 INSTALLATION



| Description of the problem   | Cause of the problem   | Countermeasure  | Comment/recommendation   |
|--|--|---|--|
| Flat belt cannot be installed or would have to be elongated too much                   | Ambient temperature too cold, resulting in flat belt becoming too stiff        | Warm flat belt up just prior to installation  | The stiffness of plastic changes with the temperature  |
|  | Flat belt length incorrectly measured (wrong order length)                     | Correctly measure required flat belt length ( <a href="#">see Chapter 5.2</a> ) and replace flat belt                                     | When ordering, the inner length of the flat belt is crucial  |
| Flat belt is easy to install but cannot be brought to calculated elongation at fitting | Flat belt too long. Flat belt length incorrectly measured (wrong order length) | Correctly measure required flat belt length ( <a href="#">see Chapter 5.2</a> ), shorten flat belt if possible or replace                 | When ordering, the inner length of the flat belt is crucial  |
| Calculated value of the shaft load exceeded by a significant amount                    | Flat belt relaxation not complete  | Let flat belt run slowly with no load; if necessary, tension in two stages ( <a href="#">see Chapter 6.3</a> )                            | The relaxation time for the Siegling Extremultus flat belts can take several operating hours   |
| Calculated value of the shaft load in steady state not reached                         | Flat belt was tensioned in many small stages (dead tensioning)                 | Replace flat belt; Tension the new flat belt in two stages at most ( <a href="#">see Chapter 6.3</a> ). Avoid multi-stage tensioning (>2) | The shaft load/elongation behavior of the flat belt changes when tensioning takes place in many small stages                           |
| Flat belt gets longitudinal grooves and/or breaks in the longitudinal direction        | Flat belt bent when installed on pulley  | Replace flat belt   | Aramide tension members may not be bent! Endless belts should be carefully placed on pulleys. Avoid longitudinal and transversal bends |

# 11.2 SPLICE OPENING



| Description of the problem                                | Cause of the problem          | Countermeasure  | Comment/recommendation   |
|---|-------------------------------|---|--|
| Splice opening with smooth joint faces (wedge splice)     | Faulty endless splicing       | Replace flat belt   | Check splicing parameters, adhesives and heating device; splice according to Forbo Movement Systems splicing instructions                                    |
| Splice opening with splintered joint faces (wedge splice) | Endless splice overload       | Replace flat belt   | Tension Siegling Extremultus flat belts only to the calculated elongation at fitting   |
|   | External mechanical influence | Replace flat belt and check machinery for stalled shafts, bearings and pulleys as well as for sharp edges that may come into contact with the flat belt | Due to the high relative speeds between a flat belt in operation and a stalled part of the machinery, such contact results in quick failure of the flat belt |
| Splice opening with smooth joint faces (Z-splice)         | Faulty endless splicing       | Replace flat belt   | Check splicing parameters and heating device; splice according to Forbo Movement Systems splicing instructions   |
| Splice opening with frayed joint faces (Z-splice)         | Endless splice overload       | Replace flat belt   | Tension Siegling Extremultus flat belts only to the calculated elongation at fitting   |
|   | External mechanical influence | Replace flat belt and check machinery for stalled shafts, bearings and pulleys as well as for sharp edges that may come into contact with the flat belt | Due to the high relative speeds between a flat belt in operation and a stalled part of the machinery, such contact results in quick failure of the flat belt |

# 11.3 NOISE GENERATION

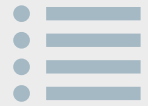

| Description of the problem         | Cause of the problem   | Countermeasure   | Comment/recommendation   |
|------------------------------------|--|--|--|
| Whistling noises                   | Slippage as a result of large transmission ratio between drive and driven (arc of contact at the small pulley too small) | Change the geometry of the machinery or increase the arc of contact at the small flat belt pulley using snub rollers             | Based on experience, a two-pulley drive can start to whistle at a transmission ratio greater than 5:1                                |
| Squeaking noises (leather coating) | Slippage due to hard, shiny leather surface  | Roughen leather surface with a wire brush and apply Extremultus spray paste. Re-tension polyamide line flat belt by approx. 0.2% | A highly compressed leather surface cannot absorb grease. By roughening the surface, the leather is capable of absorption once again |
| Squeaking noises (rubber coating)  | Load and thus creep too high   | Recalculate and replace flat belt  | Over the long term performance can only be achieved with a larger belt pulley diameter and/or wider flat belts                       |
| Banging/flapping noises            | Splice causes flapping noises but shows no signs of damage   | No intervention necessary  | Welded and bonded splices usually exhibit different bending stiffness than the rest of the belt                                      |
|                                    | Splice is damaged  | Replace flat belt  | <a href="#">See Chapter 11.2</a>   |

# 11.4 POOR BELT TRACKING

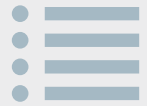

| Description of the problem  | Cause of the problem   | Countermeasure  | Comment/recommendation  |
|---|--|---|---|
| Flat belt runs off of the pulley  | Pulleys are not properly aligned   | Align pulleys parallel and flush to one another   | Misaligned pulleys (especially crowned pulleys) result in significantly higher loads and shorter belt life cycles. If the flat belt runs over the edge it is destroyed very quickly   |
|   | Flat belt overtensioned  | Reduce belt tension (observe recommended elongation at fitting)<br><br>Cantilevered bearing:<br>Calculate shaft deflection and increase shaft diameter if necessary | If the flat belts in the machinery are tensioned too high, the shafts on the pulleys can be deflected, causing the alignment of the pulleys to change.  |
|   | Pulleys are dirty  | Clean pulleys   | Performing regular maintenance on the machinery results in a longer lifetime for the flat belts   |
|   | Pulleys are not crowned  | Lathe pulleys into a crowned shape  | For information on crown heights <a href="#">see Chapter 8.1</a>  |
| Flat belt drifts, flat belt <b>regularly</b> slides on the pulley (moves from one side of the pulley to the other and back) | The endless splicing in the flat belt has a kink or the flat belt is bowed | Countermeasure only necessary if the flat belt is required to run extremely smoothly  | During production it is not always possible to guarantee the complete absence of tension in the material. This can result in a curvature of the material. As a rule the curvature flattens out with minimal elongation at fitting, <a href="#">see Chapter 6.1</a><br><br>If it is necessary for the flat belt to run extremely smoothly, this can be achieved through measures such as splicing flat belts in the bend or cutting off the belt edges after splicing. |
| Flat belt slides on the pulley irregularly (runs from one side of the pulley to the other and back)                         | Cylindrical pulley is grooved  | Lathe pulleys, avoid grooves  | Grooves can cause a threading effect which influences the tracking of the flat belt   |
|   | Crown of the pulley incorrectly selected                                   | Lathe pulleys into a crowned shape  | For information on crown heights <a href="#">see Chapter 8.1</a>  |
|   | Pulleys are dirty  | Clean pulleys   | Performing regular maintenance on the machinery results in a longer lifetime for the flat belts   |

# 11.4 POOR BELT TRACKING

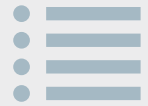

| Description of the problem                                   | Cause of the problem  | Countermeasure   | Comment/recommendation   |
|--|---|--|--|
| Flat belt flaps  | Transversal vibrations (exciter frequency corresponds to the transversal eigenfrequency of the flat belt) | Change belt tension (observe recommended elongation at fitting); change speed; change freely-vibrating length (e.g. installation of steady roller) | In the worst-case scenario the resonance between the exciter and eigenfrequency can destroy the flat belt. Please contact Forbo Movement Systems prior to taking any of the aforementioned countermeasures.  |
| Flat belt slips (no/reduced performance/ power transmission) | Belt tension too low  | Increase belt tension (observe recommended elongation at fitting)  | If there is no improvement or the recommended elongation at fitting is exceeded, please contact Forbo Movement Systems   |
|  | Flat belt too long. Flat belt length incorrectly measured (wrong order length)                            | Correctly measure required flat belt length ( <a href="#">see Chapter 5.2</a> ), shorten flat belt if possible or replace                          | When ordering, the inner length of the flat belt is crucial  |
| Flat belt gets excessively hot                               | Insufficient belt tension, strong creep   | Increase belt tension (observe recommended elongation at fitting)  | If there is no improvement or the recommended elongation at fitting is exceeded, please contact Forbo Movement Systems   |
|  | Bending frequency too high  | Reduce speed   | If there is no improvement please contact Forbo Movement Systems   |
| Pulleys get excessively hot                                  | Belt bearing overload, relaxation of flat belt not complete   | Let flat belt run slowly with no load; if necessary, tension in two stages ( <a href="#">see Chapter 6.3</a> )                                     | The relaxation of Siegling Extremultus flat belts can take several operating hours or more. If it is not possible to tension the flat belt in two stages, design the machinery bearings for the initial value of the shaft load. Please contact Forbo Movement Systems |
|  | Overload of belt bearings due to polyamide tension member drying out                                      | In constantly dry climate: Relax belt slightly<br><br>In variable climate: Use flat belt with different tension member material                    | Polyamide is susceptible to changes in ambient temperature and humidity. Should you encounter any problems please contact Forbo Movement Systems   |
| Narrowing  | Flat belt overstretched (elongation at fitting too high)  | Change flat belt, reduce belt tension (observe recommended elongation at fitting)  | Please contact Forbo Movement Systems regarding the calculation of the flat belt   |



# 11.5 WEAR

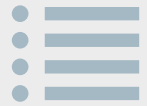

| Description of the problem                        | Cause of the problem  | Countermeasure  | Comment/recommendation   |
|---|---|---|--|
| Wear on underside of flat belt                    | Friction during normal operation  | No countermeasure necessary/possible  | Friction/wear on the underside of the flat belt is normal. The flat belt is to be considered a wearing part  |
|   | Belt tension too low or power to be transmitted is too high (excessive slip)          | Increase belt tension (observe recommended elongation at fitting)   | The flat belt is partially or entirely operated in the slippage area. If there is no improvement or the recommended elongation at fitting is exceeded, please contact Forbo Movement Systems |
|   | Pulleys are dirty   | Clean pulleys   | Performing regular maintenance on the machinery results in a longer lifetime for the flat belts  |
|   | Grooves or damage to the pulleys  | Lathe pulleys, avoid grooves  | Damage to the surface of the pulley can damage the underside of the flat belt  |
|   | Pulleys are not perfectly aligned   | Align pulleys parallel and flush to one another   | Misaligned pulleys (especially crowned pulleys) result in significantly higher loads and shorter belt life cycles  |
|   | Pulleys have incorrect geometry   | Design pulleys as crowned or cylindrical  | For information on crown heights see <a href="#">Chapter 8.1</a>   |
|   | Flat belt touches machinery parts   | Check machinery for stalled shafts, bearings and pulleys as well as for sharp edges that may come into contact with the flat belt   | Due to the high relative speeds between a flat belt in operation and a stalled part of the machinery, such contact results in quick failure of the flat belt                                 |
| Leather surface hardened, coarse abrasion         | Roughen leather surface with a wire brush and apply Extremultus spray paste           | Leather is a natural product that loses its special properties without regular care. The leather surface should be soft, greasy and dull. See <a href="#">Chapter 6.4</a> for care instructions |  |
| Wear on underside of flat belt with fine red dust | Longitudinal vibrations   | Replace the flat belt with another belt with a suitable tension member  | Longitudinal vibrations can only be influenced by the use of a flat belt with a different tension member material. Please contact Forbo Movement Systems                                     |
| Wear on top face of flat belt                     | Wear during the course of normal operation from medium to be transported (e.g. paper) | No countermeasure necessary/possible  | Wear on the top face of the flat belt during the course of transport is normal. The flat belt is to be considered a wearing part   |
|   | See "Wear on the underside of the flat belt"  | See "Wear on the underside of the flat belt"  | See "Wear on the underside of the flat belt"   |

# 11.5 WEAR



| Description of the problem  | Cause of the problem  | Countermeasure  | Comment/recommendation  |
|---|---|---|---|
| Wear on the edge(s) of the flat belt  | Flat belt touches machinery parts   | Align pulleys with one another, check the crowning of the pulley, check machinery for stalled shafts, bearings and pulleys as well as for sharp edges that may come into contact with the flat belt | Due to the high relative speeds between a flat belt in operation and a stalled part of the machinery, such contact results in quick failure of the flat belt  |
|   | Flat belt touches flanged pulley  | Align pulleys, check crowning of pulleys, dismantle flanged pulleys   | Avoid flanged pulleys in general. However, if flanged pulleys are unavoidable, see notes in <a href="#">Chapter 8.1</a>   |
|   | Edges not sawn (polyamide line in gang saw with shifter)                            | Replace flat belt. Mention sawn edges when re-ordering.   | When operated with a shifter, sawn edges on flat belts in the polyamide line have proven to have longer service lives than cut edges.   |
| Ply separation (delamination)   | Pulley diameter smaller than recommended minimum                                    | Replace pulley with a larger one or select Siegling Extremultus product with corresponding minimum pulley diameter  | Siegling Extremultus flat belts are manufactured from several layers in a "sandwich design". When the pulleys are too small, the tensions between the layers are so big that it leads to separations between the layers |
|   | External mechanical influences, peeling the surface                                 | Replace flat belt and check machinery for stalled shafts, bearings and pulleys as well as for sharp edges that may come into contact with the flat belt   | Due to the high relative speeds between a flat belt in operation and a stalled part of the machinery, such contact results in quick failure of the flat belt  |
|   | Bonding strength between the layers too low   | Replace flat belt   | If there is ply separation on a Siegling Extremultus flat belt and the minimum pulley diameter has been met, please contact Forbo Movement Systems immediately  |
| Ply separation (delamination) in splice area                                    | Overloaded endless splice or faulty endless splice see <a href="#">Chapter 11.2</a> | <a href="#">see Chapter 11.2</a>  | <a href="#">see Chapter 11.2</a>  |
| Flat belt gets longitudinal grooves and/or breaks in the longitudinal direction | Pulley(s) designed as conical-cylindrical or crowned with sharp peak in the middle  | Use crowned or cylindrical pulleys  | For information regarding the recommended geometries of pulleys <a href="#">see Chapter 8.1</a>   |
|   | Belt runs up on flanged pulley  | Align pulleys, check crowning of pulleys, dismantle flanged pulleys   | Avoid flanged pulleys in general. However, if flanged pulleys are unavoidable, see notes in <a href="#">Chapter 8.1</a>   |

# 11.6 CHANGES IN PROPERTIES

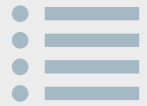

| Description of the problem               | Cause of the problem                          | Countermeasure   | Comment/recommendation  |
|--|---|--|---|
| Cross crackings in the rubber surface    | Ageing of the rubber material                 | No countermeasure necessary/possible   | Cross crackings are a familiar phenomenon with ageing rubber material subject to constant dynamic load  |
| Degradation                              | Influence of incompatible media               | Examine temperatures and chemicals used and use suitable/resistant flat belts  | Forbo Movement Systems has a variety of Siegling Extremultus flat belts in its range that all have different resistances to temperature and/or chemicals. Should you encounter any problems please contact Forbo Movement Systems   |
| Brittleness, discoloration               | Effect of UV rays                             | Protect flat belts from direct UV rays or use UV-resistant flat belts  | Depending on the duration and intensity of the exposure, plastics chemically degrade (age) under the influence of UVA, B and C rays (sunlight). The UV rays cause brittleness and color change (discoloration) in the material. Forbo Movement Systems has special products in its range for use in applications in which the flat belts are exposed to increased UV rays. Should you encounter any problems please contact Forbo Movement Systems. |
| Shaft load/transmissible power decreases | Influence of ambient temperature and humidity | Control climatic conditions, observe specifications for the flat belts, if necessary replace the flat belt with another one with a suitable tension member | Polyamide is susceptible to changes in ambient temperature and humidity. Should you encounter any problems please contact Forbo Movement Systems  |





# 12 GLOSSARY

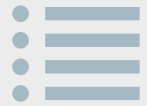

| A | Term                        | Explanation   |
|---|-----------------------------|---|
|   | Abrasion                    | Abrasion, also known as wear, refers to the loss of material on the surface of materials during use. Abrasion is caused by mechanical stress (e.g. friction). Depending on the material and surface properties, particles (dust) are released from the surfaces in contact (e.g. flat belts and pulleys).                                   |
|   | Antistatic                  | Property of a component that enables it to discharge electrostatic charges in a targeted manner to prevent sudden discharging. Antistatic Siegling Extremultus flat belts are also fitted with conductive components. The resistance ( $R_{Dj}$ as per ISO 21178) is under $3 \cdot 10^8 \Omega$ .  |
|   | Aramide                     | High-strength tension member material with high E-modulus. It is used in Siegling Extremultus flat belts in the form of cords (truly endless flat belts) or as yarn in mixed fabrics together with polyester yarn.  |
|   | Arc length                  | Length of the flat belt in contact with the pulley by way of the arc of contact.  |
|   | Arc of contact              | The contact area, in angular degrees, in which the flat belt encompasses the pulley.  |
| B | B_Rex                       | Forbo Movement Systems software used to design belt drives and select suitable Siegling Extremultus flat belts.   |
|   | Basic elongation at fitting | Elongation value used when fitting the flat belt in order to transmit the required effective pull without taking the centrifugal force into consideration.  |
|   | Belt construction           | Structure of the flat belt. Please see <a href="#">Chapter 2.2</a> for more information.  |
|   | Belt edge processing        | Coating/sealing the belt edge/flat belt edge, generally using the coating material. Please see <a href="#">Chapter 7.4</a> for more information.  |
|   | Belt tension                | The tension in the flat belt required for force-fit power transmission. The required belt tension is set by fitting the flat belt at a defined elongation at fitting.   |
|   | Bending frequency           | Number of bends made by a flat belt per unit of time. Example: If a belt completes a full revolution over two pulleys within one second, the bending frequency is $2 \text{ 1/s} = 2 \text{ Hz}$ .  |
|   | Butt splice                 | Type of splice used for some Siegling Extremultus flat belts in the polyurethane line. The ends of the flat belts are melted together on the face and joined. Please see <a href="#">Chapter 7.2</a> for more information.  |
| C | Centrifugal force           | The centrifugal force is a force that “pulls” the flat belt on the pulley towards the outside, reducing the shaft load. It is, however, a pseudo force (not a real force) due to inertia. Opposed to this force is the centripetal force (real force). The centrifugal force is not to be ignored, especially when it comes to high speeds. |
|   | Climate resistance          | Climate resistance refers to the ability of a Siegling Extremultus flat belt to reliably transmit the necessary forces even in varying climatic conditions (e.g. relative humidity).  |
|   | Cord                        | See Truly endless flat belt   |
|   | Creep                       | Creep refers to how the elastic behavior of the flat belt material compensates for the differences in force and elongation in the belt strands ( $F_1$ and $F_2$ ) caused by the effective pull $F_U$ . During normal operation flat belts should be operated in this slip area.  |
|   | Cross crackings             | A phenomenon that occurs when dynamically stressed rubber ages.   |
|   | Crown                       | See Crowning  |



| Term                         | Explanation  |
|------------------------------|--|
| Crowning                     | Curvature of the pulley faces enabling the flat belt to track in a centered position. Please see <a href="#">Chapter 8.1</a> for more information.   |
| <b>D</b> Damping             | Describes the loss in amplitude of a vibration over time. The greater the damping of the flat belt, the faster the vibrations are reduced following sudden or periodic excitation.   |
| Dead tensioning              | A phenomenon that can occur when installing new flat belts and tensioning them in many small stages. The physical properties of the flat belt or tension member are changed to such an extent that it is no longer possible to guarantee reliable power transmission. Please see <a href="#">Chapter 6.3</a> for more information. |
| Direction of movement        | The installation direction of the Siegling Extremultus flat belt recommended by Forbo Movement Systems. The direction of movement or installation direction can be crucial when it comes to preventing an opening in the splice, especially for flat belts featuring a wedge splice.   |
| Drag Belts                   | Siegling Extremultus flat belts developed specifically for drag belt conveyors. Both the top face and underside feature a low-friction textile coating with special electrostatic properties. Please see <a href="#">Chapter 2.9</a> for more information.   |
| Drive pulley                 | The pulley on the motor or turbine that is driven and thereby transfers effective pull to the flat belt.   |
| Driven pulley                | The pulley on the generator or working machine to which the flat belt transfers the effective pull or torque of the drive pulley.  |
| <b>E</b> Effective pull      | The force exerted on the flat belt during power transmission at a given power and speed. Please see <a href="#">Chapter 2.6</a> for more information.  |
| Elastomers                   | Synthetic materials that are malleable yet resistant to deformation (e.g. rubber). Elastomers consist of wide-mesh, cross-linked polymers. The wide meshing allows the material to stretch under tensile loading.  |
| Elastic Food Tapes           | Specially developed Siegling Extremultus flat belts for use in areas where hygiene is vital, such as the food industry. Further information can be found in <a href="#">Chapter 2.9</a> .  |
| Electrostatics               | The study of stationary electric charges, load distributions and bodies charged with electrical fields. Differences in potential are created in flat belts due to the constant contact and separation of the flat belts and the pulleys (triboelectric effect). These differences can cause damage if discharge is uncontrolled.   |
| Elongation                   | A change in the length of the flat belt as a result of an external force acting upon it.   |
| Elongation at fitting        | In order to transmit power/force, the flat belt must be tight in the machinery. The elongation at fitting is expressed as a percentage the elongation, or the change in length of the flat belt, necessary to achieve the required tension.  |
| E-modulus, elasticity module | A material constant describing the relationship between the tensioning and the elongation of a material in the elastic deformation area. The higher a material's E-modulus, the more tensioning, or force per unit of surface area, is required to elongate (change the length) 1% of the material, for example.                   |
| Endless belt                 | A flat belt with endless splicing as described in <a href="#">Chapter 7.2</a> (except for truly endless flat belts)  |
| Endless splicing             | Splice in the flat belt according to <a href="#">Chapter 7.2</a> .   |
| Extremultus Product Finder   | Online tool to help find products quickly and easily (for Siegling Extremultus flat belts). Please see Chapter 4.4 for more information. Available at: <a href="http://www.forbo.com/movement/&gt;E-Tools">www.forbo.com/movement/&gt;E-Tools</a>  |
| Extremultus spray paste      | Cleaning agent for Siegling Extremultus Power Transmission Belts with leather coating. Item number: 880026.  |

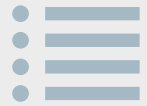

| F | Term                            | Explanation  |
|---|---------------------------------|--|
|   | Fabric                          | A threading system crossing warp threads (lengthways) and weft threads (crossways) at right angles. Used as the tension member in a variety of Siegling Extremultus flat belts. Please see <a href="#">Chapter 2.2</a> for more information.   |
|   | Fabrication                     | Fabrication refers to cutting the belt to length and width as well as preparing and creating the splice for the Siegling Extremultus flat belt. Depending on customer needs, fabrication can include some or all points.   |
|   | Fastener, mechanical            | Special fastener for some Siegling Extremultus flat belts. Wire clamps or hinges are pressed into the ends of the flat belt and then connected with a wire or pin. Please see <a href="#">Chapter 7.2</a> for more information.  |
|   | Flanged pulley                  | A pulley with an extra one or two “walls” on the pulley edges. Please see <a href="#">Chapter 8.1</a> for more information.  |
|   | Flash Star™                     | Siegling Extremultus product with HC+ classification. See Highly Conductive (HC/HC+)   |
|   | Folder Gluer Belts              | A Siegling Extremultus flat belt specially developed for use in box-folding machines. The top face and often the underside feature coating materials with a high level of grip and high abrasion resistance. Please see <a href="#">Chapter 2.9</a> for more information.  |
|   | Food safe                       | Siegling Extremultus flat belts that comply with certain criteria (e.g. FDA or EU), allowing them to be used in the food industry.   |
|   | Force peak                      | A short-term increase in the load on the flat belt (e.g. during start/stop operation).   |
|   | Friction coefficient            | The friction coefficient $\mu$ is a measurement of the friction force compared to the contact pressure. The friction coefficient depends on the materials and the texture. In this case, the materials and surfaces of the flat belts (underside) and the pulleys are crucial  |
|   | Full load                       | Machinery generally has three different operating modes: No load, partial load and full load. Full load describes the operating mode in which maximum power transmission occurs.   |
| G | Grip Star™                      | Siegling Extremultus product with a thermoplastic high or medium grip coating (coating material R). Grip Star™ products boast all the advantages of rubber without its typical ageing effects like brittleness and cross crackings.  |
| H | Heating clamp/device            | Device used to create a Z-splice, wedge splice, butt splice or overlap splice.   |
|   | Highly Conductive (HC/HC+)      | <p>Property of a component that enables it to discharge electrostatic charges in a targeted manner to prevent sudden discharging. Siegling Extremultus flat belts are equipped with conductive components when assembled.</p> <p>HC: Antistatic properties must be present and there must be conductivity on the surface in a longitudinal direction (resistance <math>R_{OB}</math> as per ISO 21178 under <math>3 \cdot 10^8 \Omega</math>).</p> <p>HC+: HC properties must be present on the top face and underside and there must be conductivity all the way through the belt (resistance <math>R_D</math> as per ISO 21178 under <math>10^9 \Omega</math>).</p> <p>Siegling Extremultus products with the HC+ property bear the Flash Star™ label.</p> |
|   | Holding time                    | Time that the heating temperature must be applied to the flat belt or the heating device in order to create a reliable Z-splice, wedge splice, butt splice or overlap splice.  |
| I | Initial value of the shaft load | Shaft load prior to relaxation of the flat belt. Please see <a href="#">Chapter 6.3</a> for more information.  |
| L | Live Roller Belts               | A Siegling Extremultus flat belt specially developed for use in driven roller conveyors. They feature high abrasion resistance and low flexing action. Please see <a href="#">Chapter 2.9</a> for more information.  |





| Term                      | Explanation  |
|---------------------------|--|
| Longitudinal vibrations   | Non-visible vibrations of the flat belt or the entire machinery in a longitudinal direction. Please see <a href="#">Chapter 9.8</a> for more information.  |
| <b>M</b> Machine Tapes    | Specially developed Siegling Extremultus flat belts used for conveying, distributing, positioning and other tasks on the production line. Please see <a href="#">Chapter 2.9</a> for more information.   |
| Minimum pulley diameter   | A minimum pulley diameter is approved for all Siegling Extremultus flat belts. Using pulleys with this approved diameter or greater eliminates the risk of damaging the flat belt as a result of excessive compression or elongation during returns.   |
| Mixed fabric              | Fabric in which the warp and weft threads are made of different materials (e.g. aramide warp threads and polyester weft threads).  |
| Moment of inertia         | The moment of inertia indicates the resistance of a rigid body to a change in its rotational movement around a given axis and thus depends on the mass distribution in relation to the axis of rotation. For large, two-pulley drives, e.g. in hydroelectric power plants, the moments of inertia of the driving and driven side are required to calculate the longitudinal eigenfrequency of the machinery. |
| <b>N</b> No load          | Machinery generally has three different operating modes: No load, partial load and full load. No load describes the operating mode in which there is no transmission of power/force.   |
| Nomenclature              | Nomenclature is the naming of the Siegling Extremultus flat belts. Each name provides a unique identification based on the materials used, properties and textures (e.g. GG 30E-30 NSTR/NSTR black).   |
| Nominal effective pull    | The nominal effective pull indicates the effective pull that can be transmitted by a flat belt with optimal elongation at fitting and optimal slip.  |
| <b>O</b> Operating factor | The operating factor $c_2$ is a safety factor by which the effective pull to be transmitted is increased, due to uneven load and/or force impact during use.   |
| Operating noise           | Operating noise is the noise created when the flat belt is in dynamic use, in other words when it is running. Sometimes unusual operating noises can indicate a defect or error. More information on this topic is given in <a href="#">Chapter 11.3</a> .   |
| Overlap splice            | Type of splice for Siegling Extremultus flat belts from the polyurethane line. The ends of the flat belts are placed one on top of the other, overlapped by 2 mm and then melted together. Please see <a href="#">Chapter 7.2</a> for more information.  |
| Order length              | The length required when ordering and manufacturing flat belts. <a href="#">Chapter 5.2</a> describes how to determine the order length.   |
| <b>P</b> Partial load     | Machinery generally has three different operating modes: No load, partial load and full load. Partial load describes the operating mode between no load (no power transmission) and full load (maximum power transmission)   |
| Plastic                   | Materials with good technical properties consisting mainly of macromolecules. Plastics can be divided into groups of thermoplasts, duroplasts and elastomers.  |
| Polyamide                 | A synthetic, semicrystalline thermoplastic material featuring outstanding strength and resilience. Polyamide boasts good chemical resistance to organic solvents and a relatively high melting temperature. However, this plastic is susceptible to changes in temperature and humidity. When used in Siegling Extremultus flat belts it is usually in the form of highly orientated sheets.                 |



| Term                                 | Explanation  |
|--------------------------------------|--|
| <b>Polyester</b>                     | Polyester is a synthetic, thermoplastic material used in fabric tension members for Siegling Extremultus flat belts. The polyester fibers used are hard-wearing and feature high elongation at break.  |
| <b>Polyurethane</b>                  | Polyurethane is a plastic or synthetic resin made from the polyaddition reaction of diols/polyols and polyisocyanates. Depending on the degree of cross-linking and variable tightness of the knitting, the polyurethane can be a duroplast, a thermoplastic or an elastomer. Thermoplastic polyurethane is used in the Siegling Extremultus flat belts. |
| <b>Power</b>                         | Physical variable calculated using the force to be transmitted and the speed of the flat belt or the torque to be transmitted and the speed.   |
| <b>Power Transmission Belts</b>      | Siegling Extremultus developed flat belts to transfer power between the driving machine element (e.g. motor) and the driven machine element (e.g. flywheel), especially for the transmission of high power levels. Please see <a href="#">Chapter 2.9</a> for more information.  |
| <b>Product Finder</b>                | Online tool to help find products quickly and easily (for Siegling Extremultus flat belts). Please see <a href="#">Chapter 4.4</a> for more information. Available at: <a href="http://www.forbo.com/movement/">www.forbo.com/movement/</a> > E-Tools  |
| <b>Pulley</b>                        | Rotationally symmetrical machine element upon which the flat belt is placed in a belt drive. The force-fit transmission of power takes place on the contact surface between the pulley and the flat belt.  |
| <b>R</b>                             |  |
| <b>Reference force</b>               | The reference force is the result of the effective pull to be transmitted, multiplied by the operating factor $c_2$ .  |
| <b>Relaxation</b>                    | The typical behavior of plastics in dynamic applications. In belt operation it means that the tension member "slackens" as a result of the "setting". This process can be recognized by the reduction in the shaft load within the first hours of the flat belt operation. Please see <a href="#">Chapter 6.3</a> for more detailed information.         |
| <b>Remaining elongation</b>          | The portion of the elongation at fitting that does not recede after the flat belt relaxes or is removed.   |
| <b>Rho value (<math>\rho</math>)</b> | The Rho value ( $\rho$ ) is calculated from the quotient of the effective pull and the surface in contact with the pulley. It refers to the capability of a tension member to transmit an effective pull.  |
| <b>Rubber</b>                        | Viscoelastic material (vulcanized rubber) belonging to the elastomer group.  |
| <b>Running-in behavior</b>           | See Relaxation   |
| <b>Running-in ratio</b>              | The running-in ratio initial describes the relationship between the initial value of the shaft load and the steady value. By multiplying the running-in ratio by the static shaft load $F_{ws}$ you get the initial shaft load acting on the bearings of the machinery directly following tensioning (prior to relaxation).                              |
| <b>S</b>                             |  |
| <b>Shaft load</b>                    | The load exerted on the shafts and bearings of the pulleys by the elongation at fitting and thus by the tension of the flat belt. The shaft load is essential to the maximum transferable power. Please see <a href="#">Chapter 2.6</a> for more information.  |
| <b>Sheet</b>                         | Highly orientated polyamide in the form of a sheet to be used as a tension member for flat belts with high power transmission. More information in <a href="#">Chapter 2.2</a>   |
| <b>Shifter, shifter roller</b>       | A device used to move flat belts (Power Transmission Belts) in a lateral direction during operation. This device is used primarily in chip drives. The shifter roller, which is either fixed or on roller bearings, comes into contact with the edge of the flat belt.   |

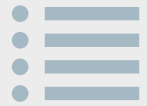

| Term                                 | Explanation  |
|--------------------------------------|--|
| Slack side of the belt               | The slack side of the belt is the part of the flat belt that is not pulled by the drive pulley. During operation there can be significantly less force there than on the tight side of the belt.   |
| Slip                                 | Refers to the difference in speeds of the mechanical elements in frictional contact with one another, expressed as a percentage. With belt drives, slip occurs between the flat belt and the pulleys. There are two types: creep (in normal operation) and slippage (overload).  |
| Slippage                             | Unlike creep, the elastic behavior of the flat belt material can no longer fully compensate for the differences in force and elongation in the belt strands ( $F_1$ and $F_2$ ) caused by the effective pull $F_U$ in this slip area. The flat belt slides off the pulley and should not be operated in this slip area.  |
| Splicing                             | See Endless splicing   |
| Splicing instructions                | Instructions for creating an endless splice  |
| Spring constant                      | The relationship between the displacement of a spring or elastic component (e.g. flat belt) and the force necessary to displace it. The spring constant depends on the material and only applies to the elastic area of the materials.   |
| Standard climate                     | For conditioning and testing plastics, DIN EN ISO 291 states that the standard climate in non-tropical countries is a climate in which the air temperature is 23 °C/+73 °F and the relative humidity is 50%, while for tropical countries it is 27 °C/+81 °F and 65%.  |
| Steady roller                        | Roller used to steady a vibrating ("flapping") belt strand in order to change the freely vibrating length.   |
| Steady state value of the shaft load | Shaft load following relaxation of the flat belt. Please see <a href="#">Chapter 6.3</a> for more information.   |
| Stiffness, bending stiffness         | The resistance of the flat belt to elastic deformation through bending when going over the pulleys.  |
| <b>T</b> Take-up range               | The range available to the tensioning station for take-up when tensioning the flat belts.  |
| Temperature stability                | Temperature stability is the ability of a Siegling Extremultus flat belt to reliably transmit the necessary forces, even at higher temperatures.   |
| Tangential Belts                     | Specially developed Siegling Extremultus Flat Belts for use as spindle drives in spinning machines and twisters. These flat belts feature particularly equal thickness along the entire length of the flat belt, even in the area of the splice, minimizing fluctuations in speed on the spindles. Please see <a href="#">Chapter 2.9</a> for more information.                                  |
| Tension                              | Mechanical tension is the force per surface unit which acts in an imaginary section through a body (e.g. the cross section of the flat belt).  |
| Tension member                       | The part of the flat belt responsible for the strength of the flat belt and thus for absorbing the forces acting on the flat belt during operation. More information in <a href="#">Chapter 2.2</a>  |
| Tensioning station                   | Device on the machinery/conveyor that applies force when tensioning the flat belt.   |
| Texture                              | Texture describes the nature of the surface of the Siegling Extremultus flat belts. This includes fine textured surface (FSTR), normal textured surface (NSTR), coarse textured surface (GSTR), inverted pyramid texture (NP), smooth (GL), smoothed (SM), fabric surface (FBRC), leather surface (LTHR) and high performance (HP). Please see <a href="#">Chapter 2.2</a> for more information. |



| Term                               | Explanation   |
|------------------------------------|---|
| Thermoplastic                      | Plastics that becomes pliable within a certain temperature range (thermoplastic). This process can be repeated at will provided the material is not thermally destroyed as a result of overheating. Due to the behavior of this material it is also possible to melt the thermoplastic material and weld it. This effect is used when creating endless splices on Siegling Extremultus flat belts with thermoplastic tension members. |
| Tight side of the belt             | The tight side of the belt is the part of the flat belt that is pulled by the drive pulley. It is where the highest forces occur on the flat belt during operation.   |
| Top face                           | The side of the flat belt that does not come into contact with the surface of the drive pulley. Previously also known as the functional side.   |
| Traction, transport capacity       | The traction or transport capacity refers to the ability of a coating and pattern of a Siegling Extremultus flat belt to reliably convey a product (e.g. food in a cutting machine or cardboard in a folder gluer machine).   |
| Transmission capacity              | see Rho value ( $\rho$ )  |
| Transmission ratio                 | The transmission ratio $i$ expresses the relationship of the speeds (and thus also the diameter of the pulleys) between the driving and driven side.<br>$i = \frac{n_1}{n_2} = \frac{d_2}{d_1}$   |
| Transversal vibrations             | Visible vibrations of the flat belt or tight side of the belt and/or slack side of the belt running vertical to the direction of movement (flat belt is "flapping"). Please see <a href="#">Chapter 9.8</a> for more information.   |
| Triboelectric effect               | An effect that describes the charging (build-up of differences in potential) of different materials through frequent rubbing together and separating. The actual quantity of the charge separation from the triboelectric effect depends on factors such as temperature, surface quality, electrical conductivity, water absorption and the position of the materials in the triboelectric series (electron affinity).                |
| Truly endless flat belt            | Flat belts featuring a cord tension member. They are coated and wound around two cylinders in the shape of a helix. Please see <a href="#">Chapter 2.2</a> for more information.  |
| <b>U</b> Underside                 | The side of the flat belt that comes into direct contact with the surface of the drive pulley. Previously also known as the running side.   |
| <b>W</b> Wear                      | See Abrasion  |
| Wedge splice                       | DA type of splice in which the ends of the Siegling Extremultus flat belts are prepared in the shape of a wedge, placed on top of one another and joined. An adhesive process is used to create the splice. Please see <a href="#">Chapter 7.2</a> for more information.  |
| Whistling                          | A high-frequency noise emitted by a flat belt during power transmission. The transmission ratio is generally above 5:1.   |
| Width-based nominal effective pull | The width-based nominal effective pull indicates the effective pull that can be transmitted at optimal elongation at fitting and optimal slip per 1 mm width of the flat belt.  |
| <b>Z</b> Z-splice                  | Type of splice for Siegling Extremultus flat belts from the polyester, aramide and polyurethane lines. The ends of the flat belts are punched using a Z-shaped punch, placed together and then melted together. Please see <a href="#">Chapter 7.2</a> for more information.  |



# 13 LEGAL NOTES



Because our products are used in so many applications and because of the individual factors involved, our operating instructions, details and information on the suitability and use of the products are only general guidelines and do not absolve the ordering party from carrying out checks and tests themselves. When we provide technical support on the application, the ordering party bears the risk of the machinery functioning properly.





## Siegling – total belting solutions

Committed staff, quality oriented organization and production processes ensure the constantly high standards of our products and services. The Forbo Siegling Quality Management System is certified in accordance with ISO 9001.

In addition to product quality, environmental protection is an important corporate goal. Early on we also introduced an environmental management system, certified in accordance with ISO 14001.



Ref. no. 333-2  
01/19 - GB - Reproduction of text or parts thereof only with our approval. Subject to change.



### Forbo Siegling service – anytime, anywhere

The Forbo Siegling Group employs more than 2,500 people. Our products are manufactured in ten production facilities across the world. You can find companies and agencies with warehouses and workshops in over 80 countries. Forbo Siegling service points are located in more than 300 places worldwide.

#### Forbo Siegling GmbH

Lilienthalstrasse 6/8, D-30179 Hannover  
Phone +49 511 6704 0  
[www.forbo-siegling.com](http://www.forbo-siegling.com), [siegling@forbo.com](mailto:siegling@forbo.com)



MOVEMENT SYSTEMS