

EXCERPT FROM PROLINK ENGINEERING MANUAL

05/19 (Ref-No. 888)

siegling prolink
modular belts

SERIES 15

Straight running belts
Pitch 12.7 mm (0.50 in)

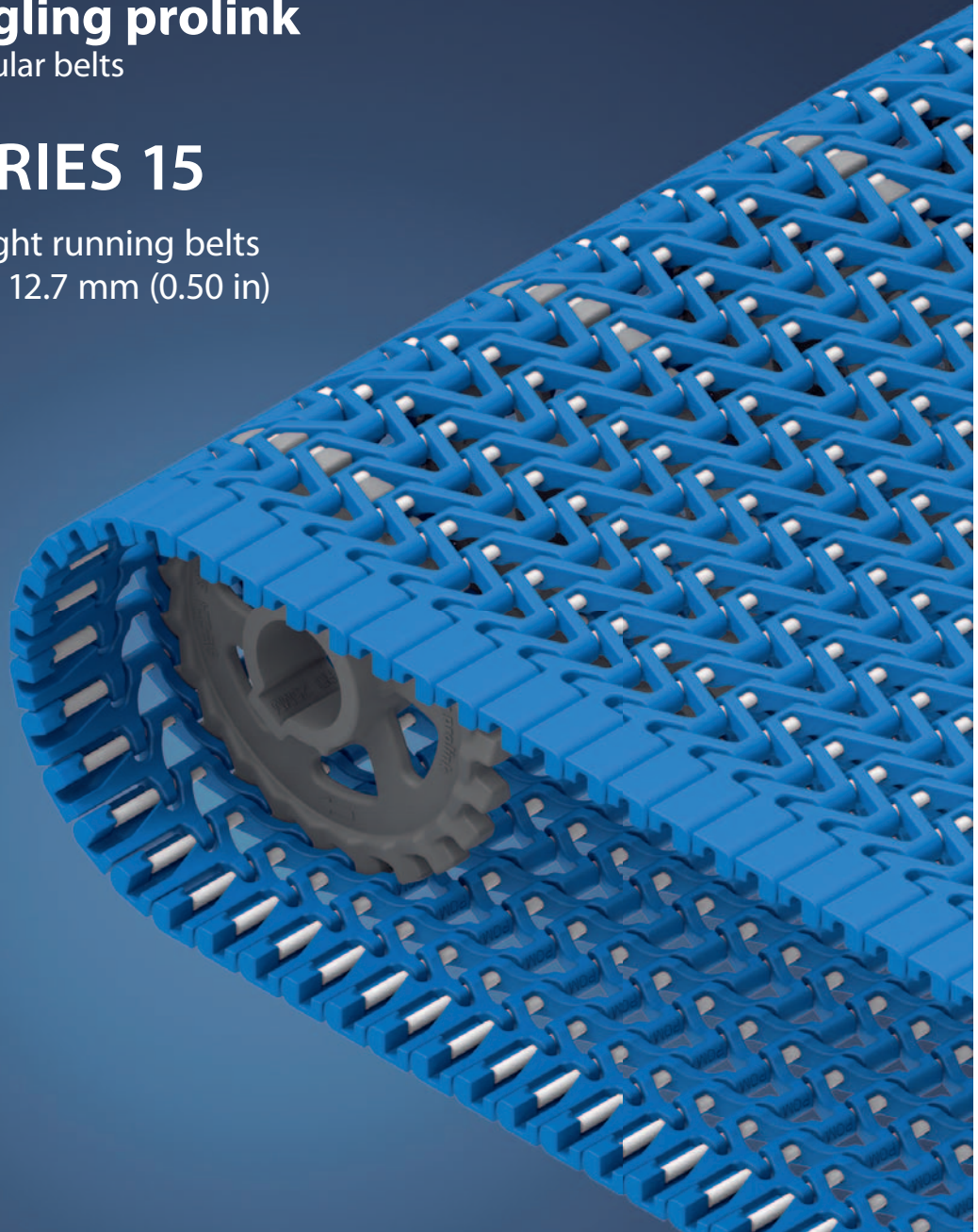

Forbo Siegling GmbH
Lilienthalstraße 6/8, D-30179 Hannover
Phone +49 511 6704 0
www.forbo-siegling.com, siegling@forbo.com

Ref. no. 888-2_1.2_S15

SERIES 15 | OVERVIEW

siegling prolink
modular belts

Straight running belts | Pitch 12.7 mm (0.50 in)

Belt for light-duty food applications utilizing 12.7 mm (0.5 in) nose bars

Side view scale 1:1

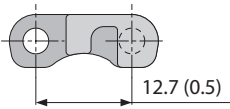

Design characteristics

- Mini-pitch belt with large open area for optimum airflow
- Scalloped underside facilitates smooth product transfer over a 12.7 mm (0.5 in) diameter nose bar.
- Open hinge for improved sanitation
- Narrow 25 mm (1 in) width increments offer superior support of conveyed products
- Solid and robust edge design incorporating improved pin retention
- Headless one-piece pin for easy installation and removal
- Sprockets with large solid tooth insures superior load transmission and long wear life

Basic data

Pitch	12.7 mm (0.50 in)
Belt width min.	203.2 mm (8 in)
Width increments	25.4 mm (1 in)
Hinge pins	3.4 mm (0.13 in)

Sprockets

in different sizes with round or square sprocket bore



Available surface pattern and opening area

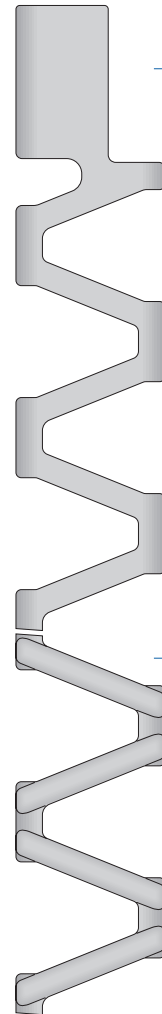

S15-47 GRT

Open (47%), lattice-shaped surface

S15-47 RSA

Open (47%), lattice-shaped surface with reduced surface area

SERIES 15 | BELT TYPES

siegling prolink
modular belts

Straight running belt | Pitch 12.7 mm (0.5 in)

S15-47 GRT | 47 % Opening | Grid top

Open area (47%) for excellent air circulation and drainage | 31 % contact area (Largest opening: 11.4 x 7.5 mm/0.45 x 0.30 in);
Smooth surface | Easy-to-clean

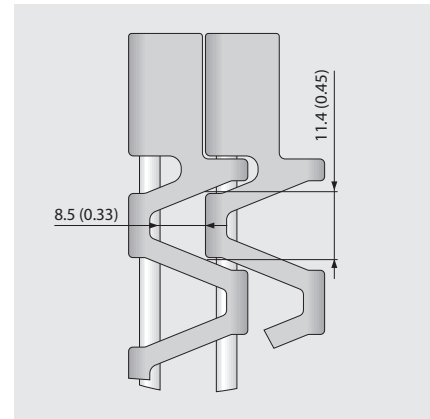
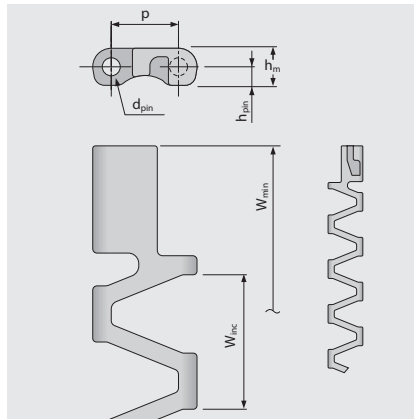
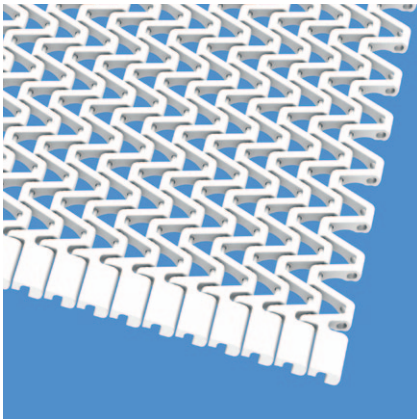

Belt dimensions

	p	d _{pin}	h _m	h _{pin}	h _s	W _{min}	W _{inc}	W _{tol}	Minimum flex radii ¹⁾				
	Pitch	Pin Ø	Thickness [mm]	Pin position [mm]	Height [mm]	Width min. [mm]	Width Increment [mm]	Width tolerance [%]	r1	r2	r3	r4	r5
mm	12.7	3.4	7.0	3.5	–	203.2	25.4	±0.20	–	6.4	25.4	38.1	12.7
inch	0.5	0.13	0.28	0.14	–	8.0	1.0	±0.20	–	0.25	1.0	1.5	0.5

Available standard materials⁴⁾

Belt		Pin		Nominal belt pull, straight		Weight		Width deviation [%]	Temperature		Certificates	
Material	Color	Material	Color	[N/mm]	[lb/ft]	[kg/m ²]	[lb/ft ²]		[°C]	[°F]	FDA ²⁾	EU ³⁾
POM	BL	PBT	UC	5	343	4.3	0.88	-0.4	-45/90	-49/194	●	●
POM	WT	PBT	UC	5	343	4.3	0.88	-0.4	-45/90	-49/194	●	●
PP	BL	PP	WT	2.5	171	2.8	0.58	-1.0	5/100	41/212	●	●
PP	WT	PP	WT	2.5	171	2.8	0.58	-1.0	5/100	41/212	●	●
PA*	BL	PBT	UC	4.5	308	3.7	0.75	0.4	-40/120	-40/248	●	●

Mold to order belts												
PP	BL	PBT	UC	2.8	192	2.8	0.58	-1.0	5/100	41/212	●	●
PP	WT	PBT	UC	2.8	192	2.8	0.58	-1.0	5/100	41/212	●	●

* Values valid for dry applications (RH < 50%). Belts in PA material will absorb water in wet environments, causing them to expand and reduce the nominal belt pull capacity.

■ BL (Blue), □ UC (Uncolored), □ WT (White)

All measurements and tolerances apply at 21 °C; for temperature deviations please see ProLink manual chapter 4.4 "Temperature influence".

All imperial dimensions (inches) are rounded off.

¹⁾ Flex radii: r1 = side flex, r2 = front flex on roller, r3 = back flex on load bearing roller, r4 = back flex on Hold Down shoe, r5 = back flex on roller

²⁾ Complies with FDA 21 CFR

³⁾ Complies with (EU) 10/2011 and (EC) 1935/2004 regulations regarding the raw materials used and the migration thresholds

⁴⁾ More materials and colors on request



MOVEMENT SYSTEMS

SERIES 15 | BELT TYPES

siegling prolink
modular belts

Straight running belt | Pitch 12.7 mm (0.5 in)

S15-47 RSA | 47% Opening | Reduced surface area

Open area (47%) for excellent air circulation and drainage | 20% contact area (Largest opening: 11.4 x 7.5 mm/0.45 x 0.30 in);
Smooth surface | Easy-to-clean

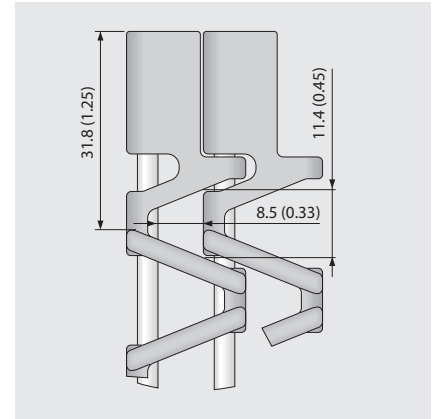
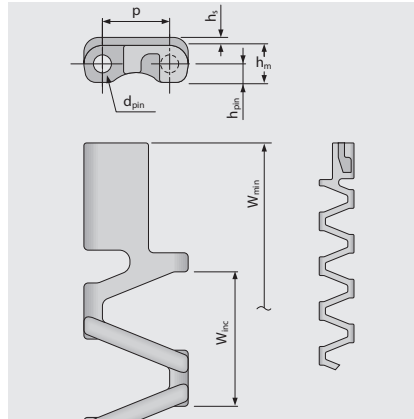
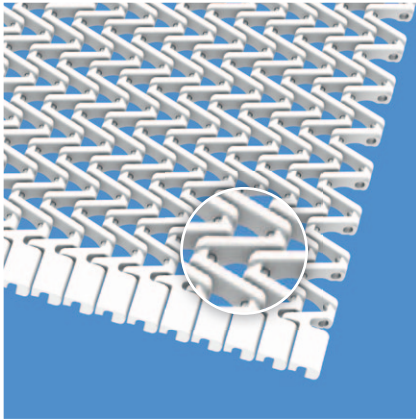

Belt dimensions

	p	d _{pin}	h _m	h _{pin}	h _s	W _{min}	W _{inc}	W _{tol}	Minimum flex radii ¹⁾				
	Pitch	Pin Ø	Thickness [mm]	Pin position [mm]	Height [mm]	Width min. [mm]	Width Increment [mm]	Width tolerance [%]	r1	r2	r3	r4	r5
mm	12.7	3.4	7.0	3.5	1.5	203.2	25.4	±0.20	–	6.4	25.4	38.1	12.7
inch	0.5	0.13	0.28	0.14	0.06	8.0	1.0	±0.20	–	0.25	1.0	1.5	0.5

Available standard materials⁴⁾

Belt		Pin		Nominal belt pull, straight		Weight		Width deviation [%]	Temperature		Certificates	
Material	Color	Material	Color	[N/mm]	[lb/ft]	[kg/m ²]	[lb/ft ²]		[°C]	[°F]	FDA ²⁾	EU ³⁾
POM	BL	PBT	UC	5	343	5.2	1.07	-0.4	-45/90	-49/194	●	●
POM	WT	PBT	UC	5	343	5.2	1.07	-0.4	-45/90	-49/194	●	●
PP	BL	PP	WT	2.5	171	3.4	0.7	-1.0	5/100	41/212	●	●
PP	WT	PP	WT	2.5	171	3.4	0.7	-1.0	5/100	41/212	●	●
PA*	BL	PBT	UC	4.5	308	4.5	0.91	0.4	-40/120	-40/248	●	●

Mold to order belts												
PP	BL	PBT	UC	2.8	192	3.4	0.7	-1.0	5/100	41/212	●	●
PP	WT	PBT	UC	2.8	192	3.4	0.7	-1.0	5/100	41/212	●	●

* Values valid for dry applications (RH < 50%). Belts in PA material will absorb water in wet environments, causing them to expand and reduce the nominal belt pull capacity.

■ BL (Blue), □ UC (Uncolored), □ WT (White)

All measurements and tolerances apply at 21 °C; for temperature deviations please see Prolink manual chapter 4.4 "Temperature influence".

All imperial dimensions (inches) are rounded off.

¹⁾ Flex radii: r1 = side flex, r2 = front flex on roller, r3 = back flex on load bearing roller, r4 = back flex on Hold Down shoe, r5 = back flex on roller

²⁾ Complies with FDA 21 CFR

³⁾ Complies with (EU) 10/2011 and (EC) 1935/2004 regulations regarding the raw materials used and the migration thresholds

⁴⁾ More materials and colors on request



MOVEMENT SYSTEMS

SERIES 15 | SPROCKETS

siegling prolink
modular belts

Straight running belt | Pitch 12.7 mm (0.5 in)

S15 SPR | Sprockets

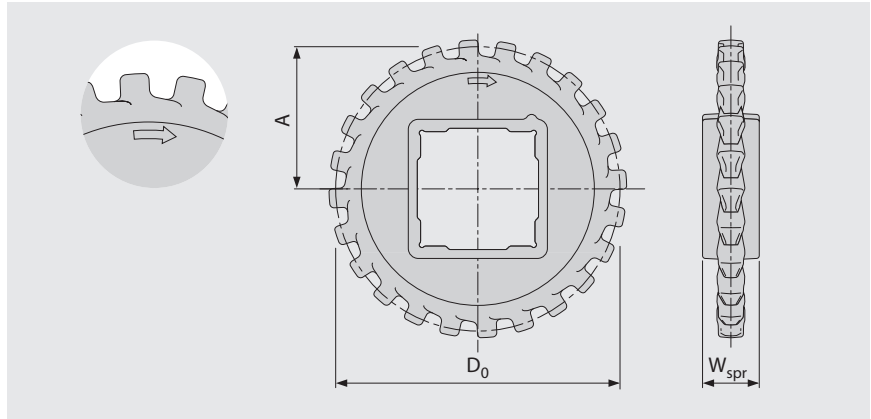

Main dimensions

Sprocket size (Number of teeth)		Z12	Z14	Z17	Z19	Z24	Z36
W _{spr}	mm	20.0	20.0	20.0	20.0	20.0	20.0
	inch	0.79	0.79	0.79	0.79	0.79	0.79
D ₀	mm	50.6	58.9	71.3	79.6	100.4	150.3
	inch	1.99	2.32	2.81	3.13	3.95	5.92
A _{max}	mm	21.8	25.9	32.1	36.3	46.7	71.6
	inch	0.86	1.02	1.26	1.43	1.84	2.82
A _{min}	mm	21.0	25.3	31.6	35.8	46.3	71.4
	inch	0.83	1.00	1.24	1.41	1.82	2.81

Shaft bores (● = Round, ■ = Square)

20	mm		●	●			
25	mm	●/■	●	●	●/■	●	●
30	mm		●	●			
40	mm					■	■
0.75	inch		●	●			
1	inch	●/■	●/■	●/■	●/■	●	●
1.25	inch		●	●			
1.5	inch					■	■

Material: PA, Color: LG

■ LG (Light gray)

All measurements and tolerances apply at 21 °C; for temperature deviations please see Prolink manual chapter 4.4 "Temperature influence".

All imperial dimensions (inches) are rounded off.

For detailed sprocket and shaft dimensions see appendix 6.3.

LEGEND

① Series		④ Type		⑥ Material		⑦ Color*	
S1 ... S15		A90	Angle 90° to conveying direction	PA	Polyamide	AT	Anthracite
② Open area/Sprocket size		BPU	Bucket profile	PA-HT	Polyamide high temperature	BL	Blue
Percentage open area		CM	Center module	PBT	Polybutylentere-phthalate	BG	Beige
Format: xx		SML	Side module, left	PE	Polyethylene	BK	Black
E.g. 20 = 20%		SMR	Side module, right	PE-MD	PE metal detectable	DB	Dark blue
For sprockets: number of teeth		SMU	Side module, universal/both sides	POM	Polyoxymethylene (Polyacetal)	GN	Green
Format: "Z"xx		UM	Universal module	POM-CR	POM cut resistant	LB	Light blue
E.g. Z12 = 12 teeth		PMC	Profile module center	POM-HC	POM highly conductive	LG	Light gray
③ Surface pattern		PMU	Profile module universal	POM-MD	POM metal detectable	OR	Orange
BSL	Base module for slider	PMU lxx	Profile module universal with indent xx = indent in mm	PP	Polypropylene	RE	Red
CTP	Cone top	CLP	Clip	PXX-HC	Self-extinguishing highly conductive material	TR	Transparent
FLT	Flat top (smooth)	IDL	Idler	POM-PE	POM side modules + PE center modules	TQ	Turquoise
FRT(X)	Friction top (Design X)	RI	High Grip insert	POM-PP	POM side modules + PP center modules	UC	Uncolored
FRT-OG	FRT without High Grip insert	SG	Module with sideguard	R1	TPE 80 Shore A, PP	WT	White
GRT	Grid top	PIN	Coupling rod	R2	EPDM 80 Shore A, vulcanized	YL	Yellow
LRB	Lateral rib	FPL	Finger plate	R3	TPE 70 Shore A, PP	⑧ Height/Diameter/ Bore size and style	
MOD	Modified module shape	SLI	Slider	R4	TPE 86 Shore A, PP	Height in mm	
NCL	No cling	SPR	Sprocket	R5	TPE 52 Shore A, PP	Format: Hxxx	
NPY	Negative pyramid	RTR	Retaining ring	R6	TPE 63 Shore A, POM	Pin diameter in mm	
NSK	Non skid	TPL	Turning panel, left	R7	TPE 50 Shore A, PP	Format: Dxxx	
NTP	Nub top (round studs)	TPR	Turning panel, right	R8	TPE 55 Shore A, PE	Bore size: SQ (= square) or RD (= round)	
RAT	Radius top	CW	Clockwise	SER	Self-extinguishing TPE	either in mm or inches	
RSA	Reduced surface area	CCW	Counterclockwise	SS	Stainless steel	Format: SQxxxMM or RDxxIN	
RTP	Roller top	⑤ Style		TPC1	Thermoplastic Copolyester	⑨ Length/Width	
RRB	Raised rib	BT	Bearing tap	-HA	Supports the HACCP concept	Pins Length in mm	
SRS	Slip-resistant surface	G	Guided	-HW	High Wear resistant material	Format: Lxxx	
		GT	Guiding tabs			Module width in mm	
		RG	Reversed guided			Format: Wxxx	
		SG	Side guard				
		ST	Strong (S5)				
		DR	Double row sprocket				
		SP	Split sprocket				
		F1, F2, F3 ...	Collapse factor modules				
		HD	Hold Down				

* For each series' standard colors please refer to the table of materials for each belt (chapter 1.2). A number of other colors are available on request. Colors can vary from the original due to the print, production processes or material used.